

MOMENT Rectangular Perch Tables

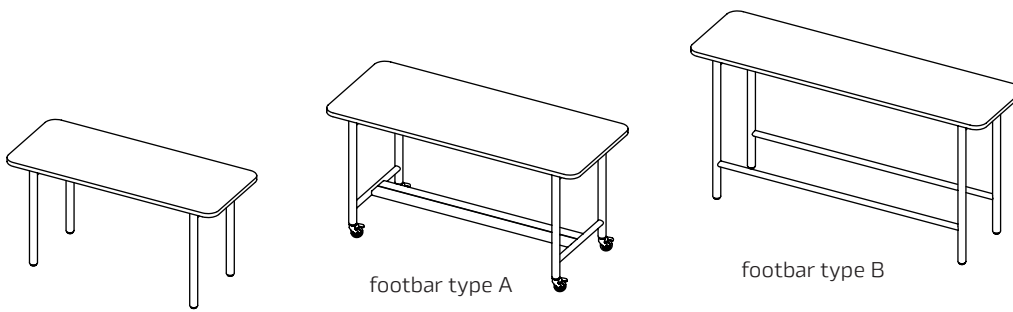

Options / Notes:

Casters: +\$120 (height not altered)

Custom Power Cutouts: +\$190

Table Height: 29.5" / 36" / 42"+\$260

***Footbar Type B:** 42" tall table ONLY

TFL Edge: edgeband ONLY

HPL Edge: edgeband / MDF 90 /

MDF Knife / MDF trim

PLY Edge: PLY 90 / PLY knife

Bag hooks standard on all tables

Dimensions			Surface Material			Footbars		Cable Cover
D	W	MODEL NUMBER	TFL	HPL/ Mirlux	PLY	TYPE A	TYPE B*	PLY
24"	48"	MTPCR2448	2040	2460	2685	+540	+310	+180
24"	60"	MTPCR2460	2165	2655	3000	+660	+520	+200
24"	72"	MTPCR2472	2295	2985	3325	+780	+555	+225
24"	84"	MTPCR2484	2415	3180	3570	+890	+595	+240
24"	96"	MTPCR2496	2475	3320	3765	+1005	NA	+260
30"	48"	MTPCR3048	2130	2605	3020	+540	+310	+180
30"	60"	MTPCR3060	2260	2960	3305	+660	+520	+200
30"	72"	MTPCR3072	2400	3180	3600	+780	+555	+225
30"	84"	MTPCR3084	2545	3400	3895	+890	+595	+240
30"	96"	MTPCR3096	2605	3565	4115	+1005	NA	+260

MOMENT Racetrack Perch Tables

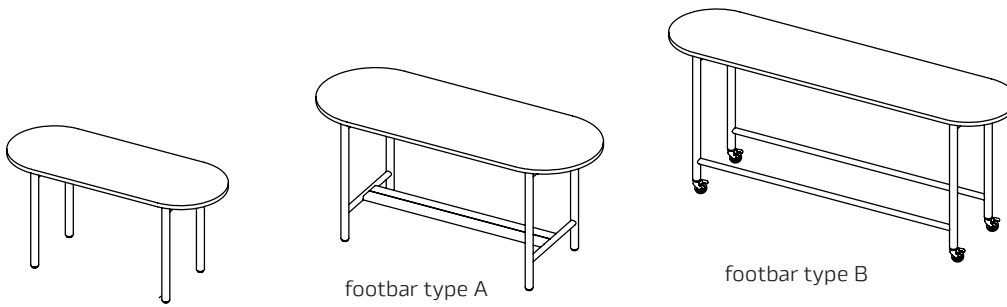

Options / Notes:

Casters: +\$120 (height not altered)

Custom Power Cutouts: +\$190

Table Height: 29.5" / 36" / 42"+\$260

***Footbar Type B:** 42" tall table ONLY

TFL Edge: edgeband ONLY

HPL Edge: edgeband / MDF 90 /

MDF Knife / MDF trim

PLY Edge: PLY 90 / PLY knife

Bag hooks standard on all tables

Dimensions			Surface Material			Footbars		Cable Cover
D	W	MODEL NUMBER	TFL	HPL/ Mirlux	PLY	TYPE A	TYPE B*	PLY
24"	60"	MTPC02460	2165	2655	3075	+660	+520	+180
24"	72"	MTPC02472	2295	2985	3325	+730	+555	+200
24"	84"	MTPC02484	2415	3180	3570	+890	+595	+225
24"	96"	MTPC02496	2475	3320	3765	+1005	NA	+240
30"	60"	MTPC03060	2260	2960	3305	+660	+520	+180
30"	72"	MTPC03072	2400	3180	3600	+730	+555	+200
30"	84"	MTPC03084	2545	3400	3895	+890	+595	+225
30"	96"	MTPC03096	2605	3565	4115	+1005	NA	+240

MOMENT Media Tables

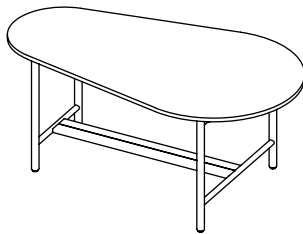
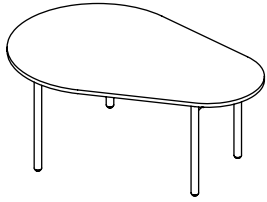

footbar type A

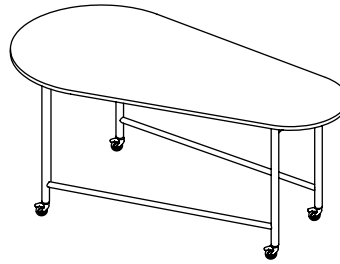

footbar type B

Options / Notes:

Casters: +\$120 (height not altered)

Custom Power Cutouts: +\$190

Table Height: 29.5" / 36" / 42"+\$260

***Footbar Type B:** 42" tall table ONLY

TFL Edge: edgeband ONLY

HPL Edge: edgeband / MDF 90 /

MDF Knife / MDF trim

PLY Edge: PLY 90 / PLY knife

Bag hooks standard on all tables

Dimensions			Surface Material			Footbars		Cable Cover
D	W	MODEL NUMBER	TFL	HPL/ Mirlux	PLY	TYPE A	TYPE B*	PLY
48"	72"	MTMD4872	3235	4285	4920	+840	+520	+225
48"	84"	MTMD4884	3480	4645	5255	+960	+555	+240
48"	96"	MTMD4896	3580	4880	5710	+1075	+595	+260

MOMENT Community Tables

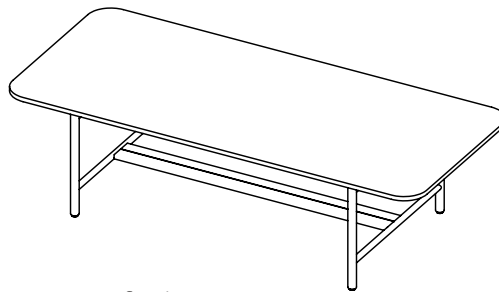
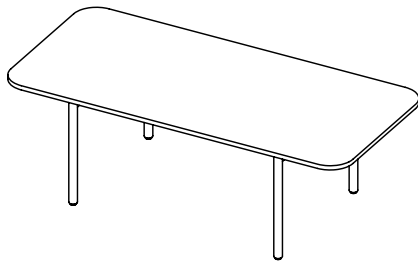

footbar type A

Options / Notes:

Casters: +\$120 (height not altered)

Custom Power Cutouts: +\$190

Table Height: 29.5" ONLY

Tops over 96" wide will be two pieces

TFL Edge: edgeband ONLY

HPL Edge: edgeband/ MDF 90 /MDF

Knife / MDF trim

PLY Edge: PLY 90 / PLY knife

Bag hooks standard on all tables

Dimensions			Surface Material			Footbars		Cable Cover
D	W	MODEL NUMBER	TFL	HPL/ Mirlux	PLY	TYPE A	TYPE B	PLY
36"	84"	MTC3684	260	3635	4320	+540	NA	+200
36"	96"	MTC3696	2880	3815	4580	+660	NA	+225
36"	108"	MTC36108	3165	4335	5060	+780	NA	+240
36"	120"	MTC36120	3255	4515	5320	+890	NA	+260
42"	84"	MTC4284	3350	4425	5075	+540	NA	+200
42"	96"	MTC4296	3455	4635	5375	+660	NA	+225
42"	108"	MTC42108	3765	5050	5875	+780	NA	+240
42"	120"	MTC42120	3870	5255	6180	+890	NA	+260
48"	84"	MTC4884	3480	4645	5385	+590	NA	+315
48"	96"	MTC4896	3580	4880	5710	+725	NA	+360
48"	108"	MTC48108	3905	5320	6265	+840	NA	+395
48"	120"	MTC48120	4015	5555	6595	+1060	NA	+430
*Surface material options may be limited above 48" table depth								
54"	84"	MTC5484	3600	4865	5700	+590	NA	+380
54"	96"	MTC5496	3710	5125	6065	+725	NA	+440
54"	108"	MTC54108	4050	5590	6645	+840	NA	+495
54"	120"	MTC54120	4165	5850	7010	+1060	NA	+555
60"	84"	MTC6084	3710	5090	5995	+775	NA	+440
60"	96"	MTC6096	3860	5050	6410	+910	NA	+520
60"	108"	MTC60108	4190	5865	7020	+1030	NA	+595
60"	120"	MTC60120	4320	6155	7435	+1140	NA	+675

MOMENT Rectangular Session Tables

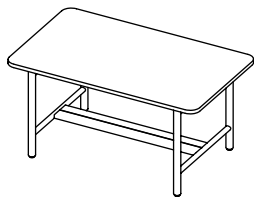

footbar type A

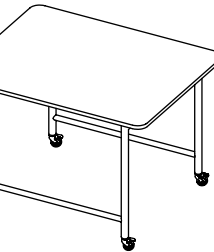
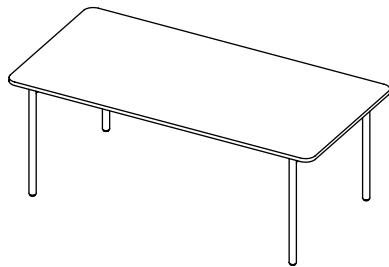

footbar type B

Options / Notes:

Casters: +\$120 (height not altered)

Custom Power Cutouts: +\$190

Table Height: 29.5" / 36" / 42"+\$260

***Footbar Type B:** 42" tall table ONLY

TFL Edge: edgeband ONLY

HPL Edge: edgeband / MDF 90 /

MDF Knife / MDF trim

PLY Edge: PLY 90 / PLY knife

Bag hooks standard on all tables

Dimensions			Surface Material			Footbars		Cable Cover
D	W	MODEL NUMBER	TFL	HPL/ Mirlux	PLY	TYPE A	TYPE B*	PLY

36"	48"	MTMR3648	2205	2880	3220	+540	+310	+180
36"	60"	MTMR3660	2360	3140	3540	+660	+520	+200
36"	72"	MTMR3672	2505	3375	3870	+780	+555	+225
36"	84"	MTMR3684	2660	3635	4320	+890	+595	+240
36"	96"	MTMR3696	2880	3815	4580	+1005	NA	+260
42"	60"	MTMR4260	2910	3625	4085	+660	+520	+200
42"	72"	MTMR4272	3125	3955	4645	+780	+555	+225
42"	84"	MTMR4284	3350	4425	5075	+890	+595	+240
42"	96"	MTMR4296	3455	4765	5375	+1005	NA	+260
48"	60"	MTMR4860	2995	3790	4450	+725	+520	+315
48"	72"	MTMR4872	3365	4155	4920	+840	+555	+360
48"	84"	MTMR4884	3480	4645	5385	+960	+595	+395
48"	96"	MTMR4896	3580	4880	5710	+1075	NA	+430

*Surface material options may be limited above 48" table depth

54"	72"	MTMR5472	3350	4475	5190	+840	+555	+440
54"	84"	MTMR5484	3600	4865	5700	+960	+595	+495
54"	96"	MTMR5496	3710	5125	6065	+1075	NA	+555
60"	72"	MTMR6072	3455	4675	5460	+1030	+555	+520
60"	84"	MTMR6084	3710	5090	5995	+1140	+595	+590
60"	96"	MTMR6096	3860	5375	6410	+1260	NA	+675

MOMENT Racetrack Session Tables

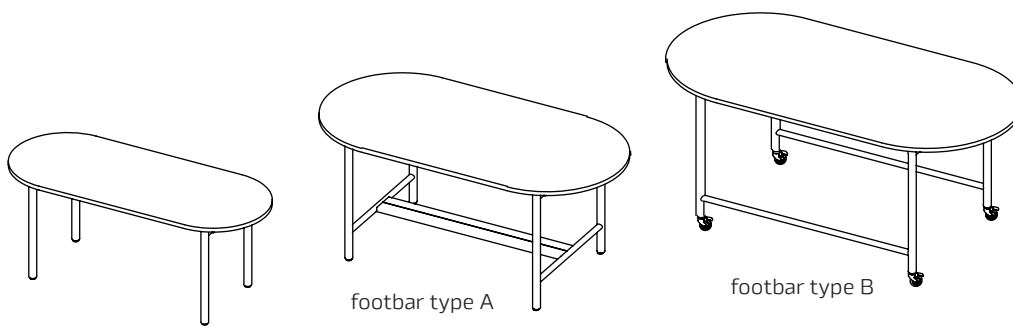

Options / Notes:

Casters: +\$120 (height not altered)

Custom Power Cutouts: +\$190

Table Height: 29.5" / 36" / 42"+\$260

***Footbar Type B:** 42" tall table ONLY

TFL Edge: edgeband ONLY

HPL Edge: edgeband / MDF 90 /

MDF Knife / MDF trim

PLY Edge: PLY 90 / PLY knife

Bag hooks standard on all tables

Dimensions			Surface Material			Footbars		Cable Cover
D	W	MODEL NUMBER	TFL	HPL/ Mirlux	PLY	TYPE A	TYPE B*	PLY
36"	60"	MTM03660	2360	3140	3540	+660	+520	+180
36"	72"	MTM03672	2505	3375	3870	+780	+555	+200
36"	84"	MTM03684	2660	3635	4320	+890	+595	+225
36"	96"	MTM03696	2880	3815	4580	+1005	NA	+240
42"	72"	MTM04272	3125	3955	4645	+780	+555	+200
42"	84"	MTM04284	3350	4295	5075	+890	+595	+225
42"	96"	MTM04296	3455	4635	5180	+1005	NA	+240
48"	72"	MTM04872	3235	4285	4920	+840	+555	+315
48"	84"	MTM04884	3480	4645	5385	+960	+595	+360
48"	96"	MTM04896	3580	4880	5710	+1075	NA	+395
*Surface material options may be limited above 48" table depth								
54"	84"	MTM05484	3600	4865	5700	+960	+595	+440
54"	96"	MTM05496	3710	5125	6195	+1075	NA	+495
60"	96"	MTM06096	3860	5375	6410	+1260	NA	+595

MOMENT Common Tables

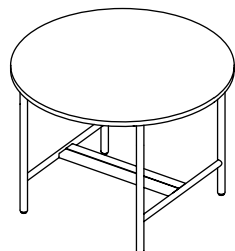
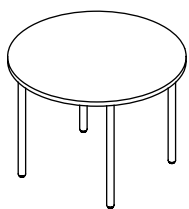

footbar type A

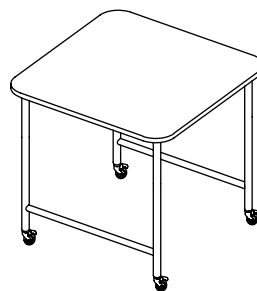
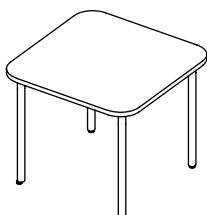

footbar type B

Options / Notes:

Casters: +\$120 (height not altered)

Custom Power Cutouts: +\$190 Table

Height: 29.5" / 36" / 42" +\$415

***Footbar Type B:** 42" tall table ONLY

TFL Edge: edgeband ONLY

HPL Edge: edgeband / MDF 90 / MDF

Knife / MDF trim

PLY Edge: PLY 90 / PLY knife

Bag hooks standard on all tables

Round			Surface Material			Footbars		Cable Cover
D	W	MODEL NUMBER	TFL	HPL/ Mirlux	PLY	TYPE A	TYPE B*	PLY
42"	42"	MTSR4242	2520	3125	3495	+520	+300	NA
48"	48"	MTSR4848	2600	3270	3685	+590	+310	NA
54"	54"	MTSR5454	2950	3600	4245	+635	+500	NA
60"	60"	MTSR6060	3165	3950	4710	+875	+510	NA

Square

D	W	MODEL NUMBER	TFL	HPL/ Mirlux	PLY	TYPE A	TYPE B*	Ply
42"	42"	MTSS4242	2520	3250	3635	+520	+310	NA
48"	48"	MTSS4848	2600	3400	3830	+615	+320	NA
54"	54"	MTSS5454	2950	3745	4415	+660	+520	NA
60"	60"	MTSS6060	3165	4110	4900	+910	+530	NA

MOMENT Table Accessories

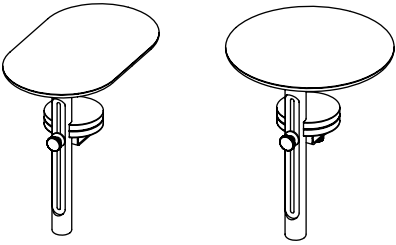
	D	W	H	MODEL NUMBER	Price
Pivot Tables					
	Racetrack				
	12"	20"	20"	MTAPTO	750
	Round				
	16"	16"	20"	MTAPTR	750

Planters

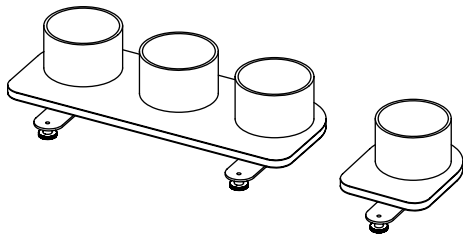

Single				
12"	9"	9"	MTAPL1	310
Triple				
12"	24"	9"	MTAPL3	500

TV Mount

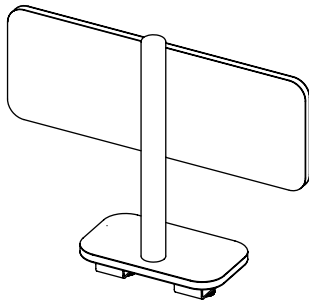

8"	28"	24"	MTATV	875
----	-----	-----	--------------	-----

Pivot Table / Planters / TV Mount can clamp onto any surface less than 1.25" thick

Cable Tower

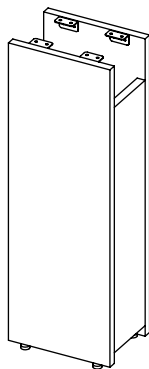

Plywood				
7"	10"	28"	MTACT28	625
7"	10"	34.5"	MTACT34	750
7"	10"	40.5"	MTACT40	875
TFL				
7"	10"	28"	MTACT28	425
7"	10"	34.5"	MTACT34	475
7"	10"	40.5"	MTACT40	525

All tables come with 5 under surface cable clips and 3 cable straps for table legs

The heights of the Cable Tower correspond to 29.5"/36"/ 42" table heights

The Cable Tower can be mounted anywhere under the table surface

MOMENT Table Cable Management

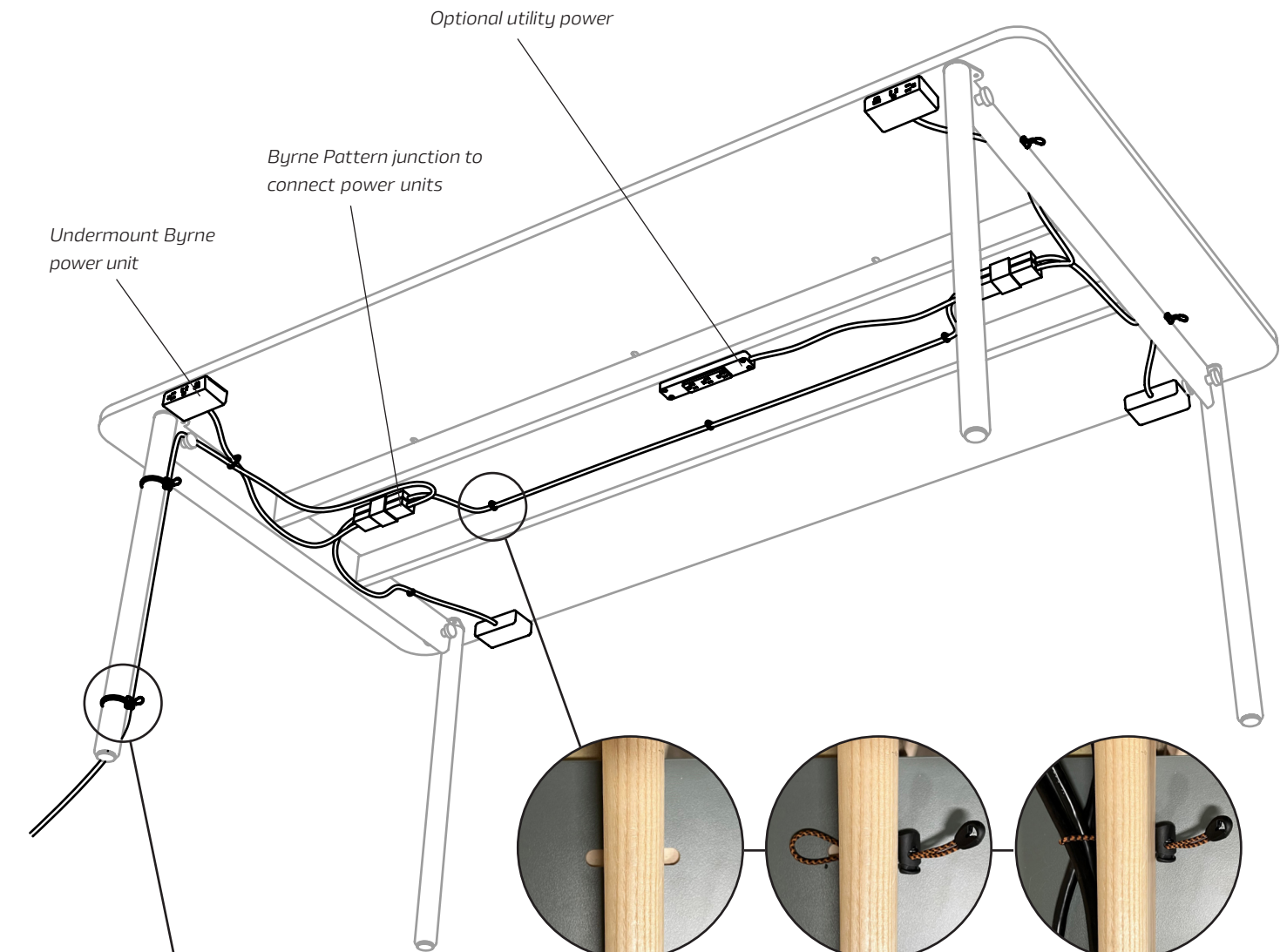

There are slots routed between the surface and the wood frame.

Bungee cords can be fed through these slots.

These bungee cords can be used to manage cables under the surface.

Standard on all tables:

Under Surface Cable Bungee

6x



Leg Cable Bungee

2x



Adjustable bungee cords offer user configurable cable management on any table leg

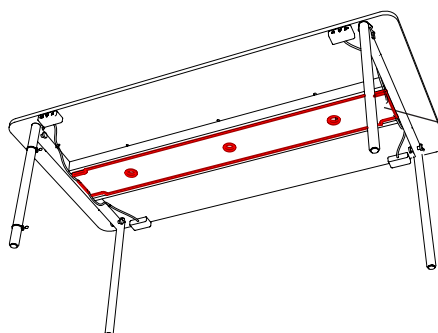

Optional plywood cable cover with magnetic attachment

MOMENT Table Power Placement

Social Tables

Meeting/Perch Tables

Community Tables

Under Surface Perimeter Power

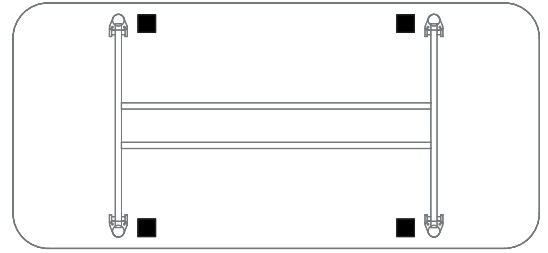
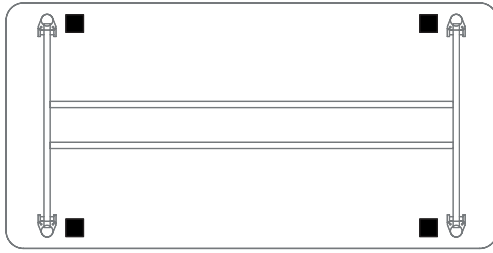
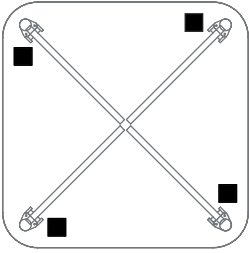

All power units are 2" back from the edge of the surface and 2" in from the interior of the table legs

Single In-Surface Power

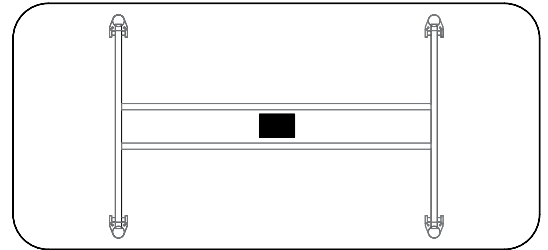
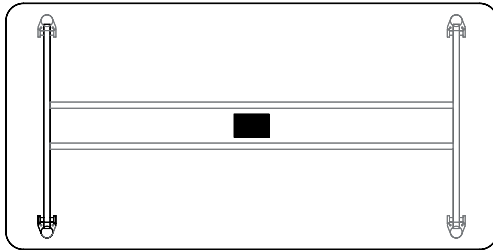
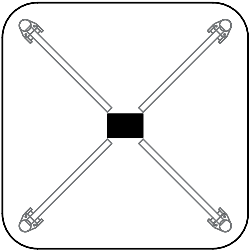

Double In-Surface Power

NA

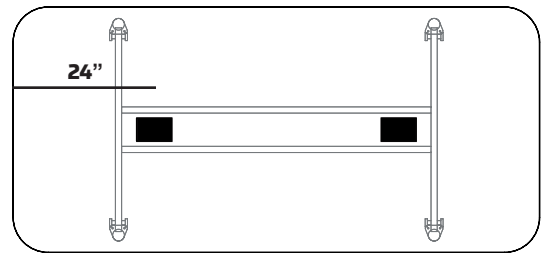
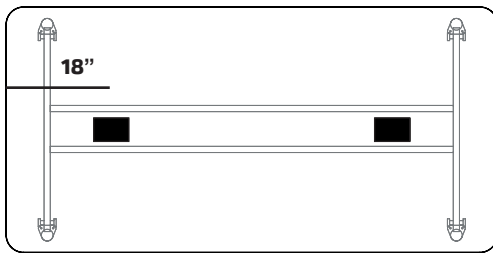

Grommet Locations

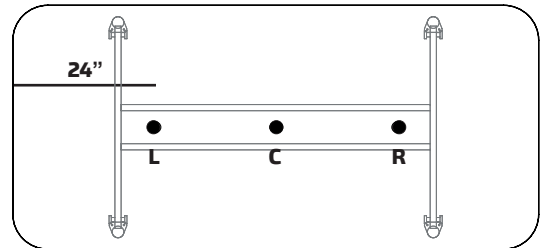
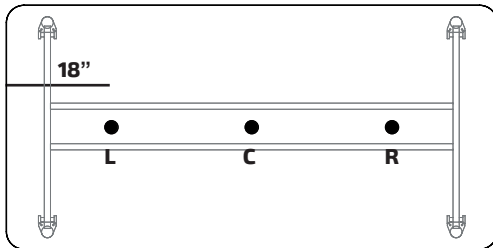
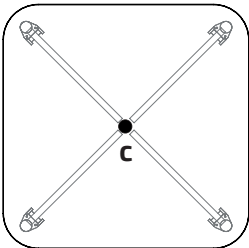

If a grommet is specified in the same location as a power unit it will be pushed 2" interior of the power unit or 2" to the right depending on the configuration. **+\$50 list per grommet.**







MOMENT Table Power Offering

Notes:

All multi-unit configurations (perimeter power / inline utility power / or double in-surface power) are accomplished using Byrne Electric's Pattern system or our Built in USB C charging system. This means all individual power units or ports are chained together and a single cord (infeed) powers the whole system.

Options:

Braided Infeed Cord: +\$125
Hardwired Infeed: +\$250
 Finish option on Byrne website.
 Select finishes may add extra cost.

Power Unit	Description	Perimeter*	Single In-Surface	Double In-Surface**
Built in 100 Watt USB C	4 port: 1 port per leg	2435	NA	NA
	This power solution is proprietary to Makr Furniture and the Moment Tables & Desks. It integrates a 100-Watt USB C charging port into each table leg. This is enough power to charge devices ranging from cell phones to full-sized laptops. In addition to power, hardware data, peripherals, and displays can pass through these ports with the use of data Hubs. Makr can work with your technology needs to help specify the proper Hub for your application. A data hub is not included in this price.			
Finch	 3 port: 2 PWR / USB A + C	2765	NA	NA
Dean	 3 port: 3 PWR 3 port: 2 PWR / 1 USB A + C	2655 3775	470 625	1260 1590
Ellora B	 4 port: 2 PWR / Dual USB A / 1 Open 4 port: 3 PWR / USB A + C	NA NA	780 780	2425 2425
Pepper	 1 port: 1 PWR	NA	155	905
HQ2	 4 port: 1 PWR / Dual USB A / 2 Qi	NA	1035	3045
Utility Power***	 3 port: 3 PWR	310	310	NA
inline	stand alone			

*Perimeter power comes with 4 power units chained together into one system with a single power infeed

**Double in-surface power comes with 2 power units chained together into one system with a single power infeed

***Utility power is mounted under the surface and will be connected in line with the other power units by default. If you want a stand alone utility power unit with its own power cord it will be a 2 port Byrne MiniTap and will cost \$145 list.