

## MOMENT Rectangular Perch Tables

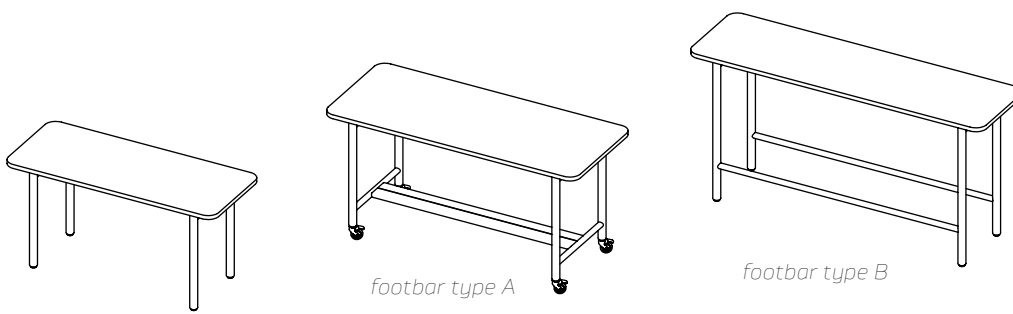

### Options / Notes:

**Casters:** +\$110 (hieght not altered)

**Custom Power Cutouts:** +\$180 **Table**

**Hieght:** 29.5" / 36" / 42"+\$240

**\*Footbar Type B:** 42" tall table ONLY

**TFL Edge:** edgeband ONLY

**HPL Edge:** edgeband / MDF 90 /

MDF Knife / MDF trim

**PLY Edge:** PLY 90 / PLY knife

**Bag hooks standard on all tables**

Dimensions			Surface Material			Footbars		Cable Cover
D	W	MODEL NUMBER	TFL	HPL/ Mirlux	PLY	TYPE A	TYPE B*	PLY
24"	48"	<b>MTPCR2448</b>	1885	2275	2485	+500	+290	+170
24"	60"	<b>MTPCR2460</b>	2000	2455	2480	+610	+480	+185
24"	72"	<b>MTPCR2472</b>	2120	2760	3070	+720	+515	+205
24"	84"	<b>MTPCR2484</b>	2230	2940	3305	+820	+550	+220
24"	96"	<b>MTPCR2496</b>	2290	3065	3480	+930	NA	+240
30"	48"	<b>MTPCR3048</b>	1970	2410	2795	+500	+290	+170
30"	60"	<b>MTPCR3060</b>	2090	2735	3060	+610	+480	+185
30"	72"	<b>MTPCR3072</b>	2220	2940	3325	+720	+515	+205
30"	84"	<b>MTPCR3084</b>	2350	3145	3600	+820	+550	+220
30"	96"	<b>MTPCR3096</b>	2410	3300	3805	+930	NA	+240

## MOMENT Racetrack Perch Tables

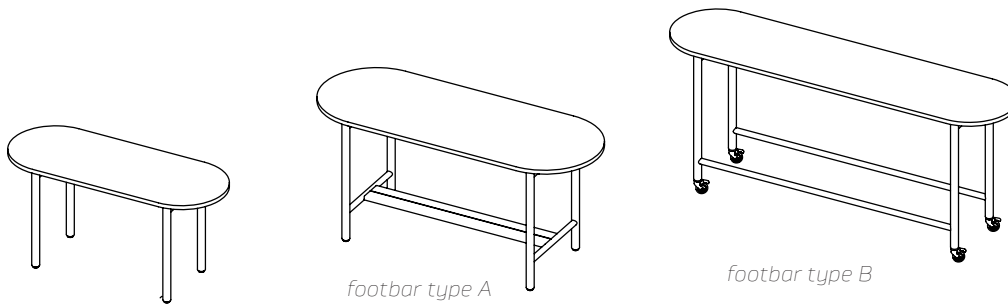

### Options / Notes:

**Casters:** +\$110 (hieght not altered)

**Custom Power Cutouts:** +\$180

**Table Height:** 29.5" / 36" / 42"+\$240

**\*Footbar Type B:** 42" tall table ONLY

**TFL Edge:** edgeband ONLY

**HPL Edge:** edgeband / MDF 90 /

MDF Knife / MDF trim

**PLY Edge:** PLY 90 / PLY knife

**Bag hooks standard on all tables**

Dimensions			Surface Material			Footbars		Cable Cover
D	W	MODEL NUMBER	TFL	HPL/ Mirlux	PLY	TYPE A	TYPE B*	PLY
24"	60"	<b>MTPC02460</b>	2000	2455	2840	+610	+480	+170
24"	72"	<b>MTPC02472</b>	2120	2760	3070	+672	+515	+185
24"	84"	<b>MTPC02484</b>	2230	2940	3305	+820	+550	+205
24"	96"	<b>MTPC02496</b>	2290	3065	3480	+930	NA	+220
30"	60"	<b>MTPC03060</b>	2090	2735	3060	+610	+480	+170
30"	72"	<b>MTPC03072</b>	2220	2940	3325	+720	+515	+185
30"	84"	<b>MTPC03084</b>	2350	3145	3600	+820	+550	+205
30"	96"	<b>MTPC03096</b>	2410	3300	3805	+930	NA	+220

## MOMENT Media Tables

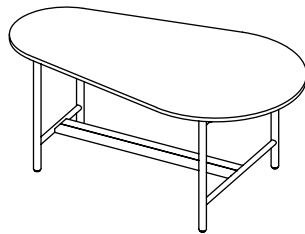
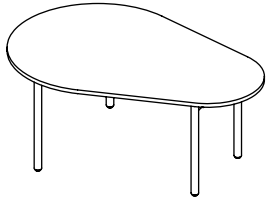

footbar type A

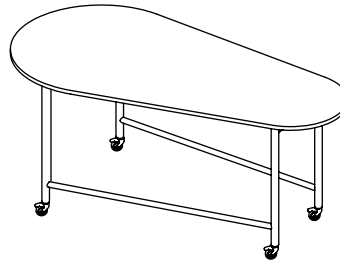

footbar type B

### Options / Notes:

**Casters:** +\$110 (hieght not altered)

**Custom Power Cutouts:** +\$180

**Table Height:** 29.5" / 36" / 42"+\$240

**\*Footbar Type B:** 42" tall table ONLY

**TFL Edge:** edgeband ONLY

**HPL Edge:** edgeband / MDF 90 /

MDF Knife / MDF trim

**PLY Edge:** PLY 90 / PLY knife

**Bag hooks standard on all tables**

Dimensions			Surface Material			Footbars		Cable Cover
D	W	MODEL NUMBER	TFL	HPL/ Mirlux	PLY	TYPE A	TYPE B*	PLY
48"	72"	<b>MTMD4872</b>	2990	3960	4550	+780	+480	+205
48"	84"	<b>MTMD4884</b>	3215	4295	4860	+890	+515	+220
48"	96"	<b>MTMD4896</b>	3310	4510	5280	+995	+550	+240

## MOMENT Community Tables

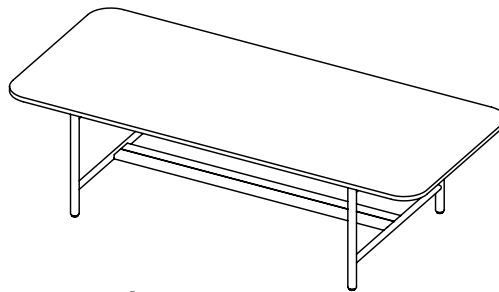
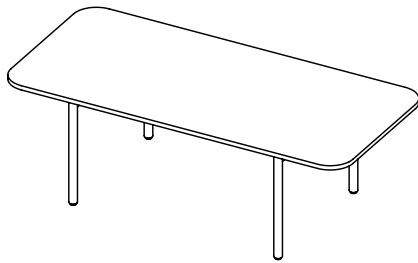

footbar type A

### Options / Notes:

**Casters:** +\$110 (hieght not altered)

**Custom Power Cutouts:** +\$180

**Table Height:** 29.5" ONLY

**Tops over 96" W will be two peice**

**TFL Edge:** edgeband ONLY

**HPL Edge:** edgeband / MDF 90 / MDF

Knife / MDF trim

**PLY Edge:** PLY 90 / PLY knife

**Bag hooks standard on all tables**

Dimensions			Surface Material			Footbars		Cable Cover
D	W	MODEL NUMBER	TFL	HPL/ Mirlux	PLY	TYPE A	TYPE B	PLY
36"	84"	<b>MTC3684</b>	2460	3360	3995	+500	NA	+185
36"	96"	<b>MTC3696</b>	2665	3530	4235	+610	NA	+205
36"	108"	<b>MTC36108</b>	2930	4010	4680	+720	NA	+220
36"	120"	<b>MTC36120</b>	3010	4175	4920	+820	NA	+240
42"	84"	<b>MTC4284</b>	3095	4090	4690	+500	NA	+185
42"	96"	<b>MTC4296</b>	3190	4285	4970	+610	NA	+205
42"	108"	<b>MTC42108</b>	3480	4670	5435	+720	NA	+220
42"	120"	<b>MTC42120</b>	3575	4860	5710	+820	NA	+240
48"	84"	<b>MTC4884</b>	3215	4295	4980	+545	NA	+295
48"	96"	<b>MTC4896</b>	3310	4510	5280	+670	NA	+330
48"	108"	<b>MTC48108</b>	3610	4920	5795	+780	NA	+365
48"	120"	<b>MTC48120</b>	3710	5135	6095	+980	NA	+400
<i>*Surface material options may be limited above 48" table depth</i>								
54"	84"	<b>MTC5484</b>	3325	4500	5270	+545	NA	+350
54"	96"	<b>MTC5496</b>	3430	4740	5605	+670	NA	+410
54"	108"	<b>MTC54108</b>	3745	5170	6145	+780	NA	+455
54"	120"	<b>MTC54120</b>	3850	5410	6480	+980	NA	+515
60"	84"	<b>MTC6084</b>	3430	4705	5545	+715	NA	+410
60"	96"	<b>MTC6096</b>	3565	4670	5930	+840	NA	+480
60"	108"	<b>MTC60108</b>	3875	5425	6490	950	NA	+550
60"	120"	<b>MTC60120</b>	3995	5690	6875	+1055	NA	+625

## MOMENT Rectangular Session Tables

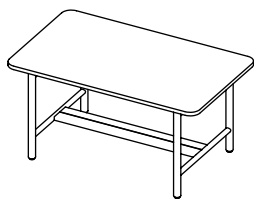

footbar type A

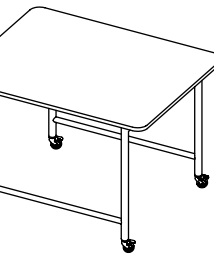
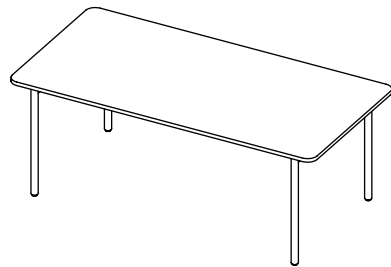

footbar type B

### Options / Notes:

**Casters:** +\$110 (hieght not altered)

**Custom Power Cutouts:** +\$180

**Table Height:** 29.5" / 36" / 42"+\$240

**\*Footbar Type B:** 42" tall table ONLY

**TFL Edge:** edgeband ONLY

**HPL Edge:** edgeband / MDF 90 /

MDF Knife / MDF trim

**PLY Edge:** PLY 90 / PLY knife

**Bag hooks standard on all tables**

Dimensions			Surface Material			Footbars		Cable Cover
D	W	MODEL NUMBER	TFL	HPL/ Mirlux	PLY	TYPE A	TYPE B*	PLY
36"	48"	<b>MTMR3648</b>	2040	2665	2975	+500	+290	+170
36"	60"	<b>MTMR3660</b>	2185	2905	3275	+610	+480	+185
36"	72"	<b>MTMR3672</b>	2315	3120	3575	+720	+515	+205
36"	84"	<b>MTMR3684</b>	2460	3360	3995	+820	+550	+220
36"	96"	<b>MTMR3696</b>	2665	3530	4235	+930	NA	+240
42"	60"	<b>MTMR4260</b>	2690	3350	3780	+610	+480	+185
42"	72"	<b>MTMR4272</b>	2890	3660	4295	+720	+515	+205
42"	84"	<b>MTMR4284</b>	3095	4090	4690	+820	+550	+220
42"	96"	<b>MTMR4296</b>	3190	4405	4970	+930	NA	+240
48"	60"	<b>MTMR4860</b>	2770	3505	4115	+670	+480	+295
48"	72"	<b>MTMR4872</b>	3110	3840	4550	+780	+515	+330
48"	84"	<b>MTMR4884</b>	3215	4295	4980	+890	+550	+365
48"	96"	<b>MTMR4896</b>	3310	4510	5280	+995	NA	+400
<i>*Surface material options may be limited above 48" table depth</i>								
54"	72"	<b>MTMR5472</b>	3095	4140	4800	+780	+515	+410
54"	84"	<b>MTMR5484</b>	3325	4500	5270	+890	+550	+455
54"	96"	<b>MTMR5496</b>	3430	4740	5605	+995	NA	+515
60"	72"	<b>MTMR6072</b>	3190	4320	5050	+950	+515	+480
60"	84"	<b>MTMR6084</b>	3430	4705	5545	+1055	+550	+550
60"	96"	<b>MTMR6096</b>	3565	4970	5930	+1165	NA	+625

## MOMENT Racetrack Session Tables

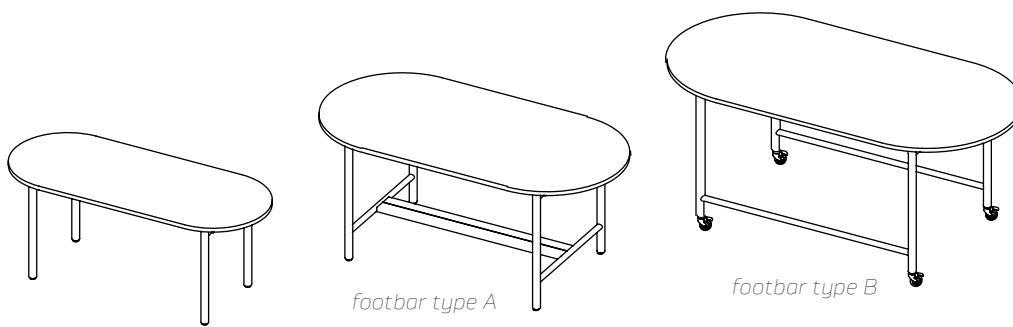

### Options / Notes:

**Casters:** +\$110 (hieght not altered)

**Custom Power Cutouts:** +\$180

**Table Height:** 29.5" / 36" / 42"+\$240

**\*Footbar Type B:** 42" tall table ONLY

**TFL Edge:** edgeband ONLY

**HPL Edge:** edgeband / MDF 90 /

MDF Knife / MDF trim

**PLY Edge:** PLY 90 / PLY knife

**Bag hooks standard on all tables**

Dimensions			Surface Material			Footbars		Cable Cover
D	W	MODEL NUMBER	TFL	HPL/ Mirlux	PLY	TYPE A	TYPE B*	PLY
36"	60"	<b>MTM03660</b>	2185	2905	3275	+610	+480	+170
36"	72"	<b>MTM03672</b>	2315	3120	3575	+720	+515	+185
36"	84"	<b>MTM03684</b>	2460	3360	3995	+820	+550	+205
36"	96"	<b>MTM03696</b>	2665	3530	4235	+930	NA	+220
42"	72"	<b>MTM04272</b>	2890	3660	4295	+720	+515	+185
42"	84"	<b>MTM04284</b>	3095	3970	4690	+820	+550	+205
42"	96"	<b>MTM04296</b>	3190	4285	4790	+930	NA	+220
48"	72"	<b>MTM04872</b>	2990	3960	4550	+780	+515	+295
48"	84"	<b>MTM04884</b>	3215	4295	4980	+890	+550	+330
48"	96"	<b>MTM04896</b>	3310	4510	5280	+995	NA	+365
<i>*Surface material options may be limited above 48" table depth</i>								
54"	84"	<b>MTM05484</b>	3325	4500	5270	+890	+550	+410
54"	96"	<b>MTM05496</b>	3430	4740	5725	+995	NA	+455
60"	96"	<b>MTM06096</b>	3565	4970	5930	+1165	NA	+550

## MOMENT Common Tables

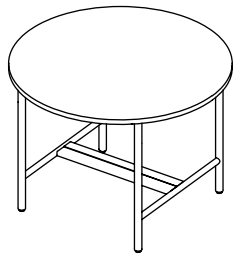
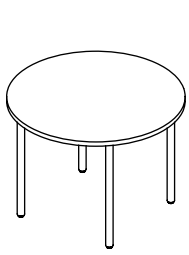

footbar type A

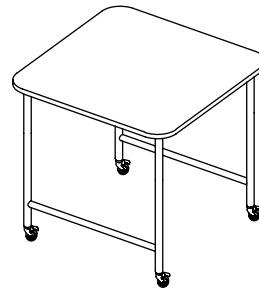
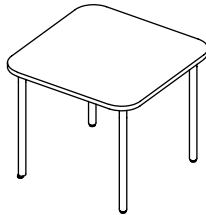

footbar type B

### Options / Notes:

**Casters:** +\$110 (hieght not altered)

**Custom Power Cutouts:** +\$180

**Table Height:** 29.5" / 36" / 42"+\$400

**\*Footbar Type B:** 42" tall table ONLY

**TFL Edge:** edgeband ONLY

**HPL Edge:** edgeband / MDF 90 /

MDF Knife / MDF trim

**PLY Edge:** PLY 90 / PLY knife

**Bag hooks standard on all tables**

### Round

Round			Surface Material			Footbars		Cable Cover
D	W	MODEL NUMBER	TFL	HPL/ Mirlux	PLY	TYPE A	TYPE B*	PLY
42"	42"	<b>MTSR4242</b>	2330	3005	33600	+500	+290	NA
48"	48"	<b>MTSR4848</b>	2405	3145	3545	+565	+300	NA
54"	54"	<b>MTSR5454</b>	2725	3460	4080	+610	+480	NA
60"	60"	<b>MTSR6060</b>	2930	3800	4530	+840	+490	NA

### Square

D	W	MODEL NUMBER	TFL	HPL/ Mirlux	PLY	TYPE A	TYPE B*	Ply
42"	42"	<b>MTSS4242</b>	2330	3005	33600	+500	+290	NA
48"	48"	<b>MTSS4848</b>	2405	3145	3545	+565	+300	NA
54"	54"	<b>MTSS5454</b>	2725	3460	4080	+610	+480	NA
60"	60"	<b>MTSS6060</b>	2930	3800	4530	+840	+490	NA

## MOMENT Table Accessories

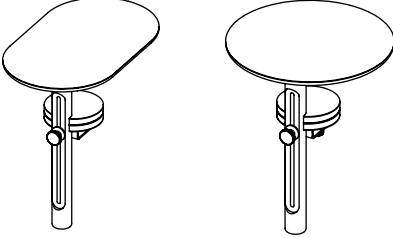
	D	W	H	MODEL NUMBER	Price
<b>Pivot Tables</b>					
	<b>Racetrack</b>				
	12"	20"	20"	<b>MTAPTO</b>	720
	<b>Round</b>				
	16"	16"	20"	<b>MTAPTR</b>	720

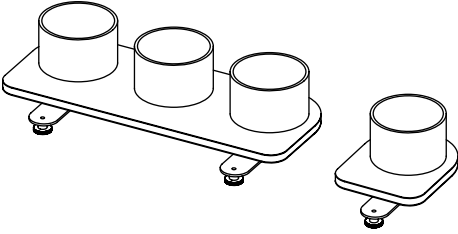
<b>Planters</b>					
	<b>Single</b>				
	12"	9"	9"	<b>MTAPL1</b>	3000
	<b>Tripple</b>				
	12"	24"	9"	<b>MTAPL3</b>	480

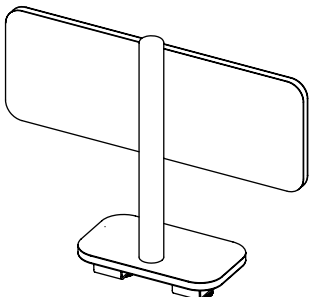
<b>TV Mount</b>	8"	28"	24"	<b>MTATV</b>	840
					

*Pivot Table / Planters / TV Mount can clamp onto any surface less than 1.25" thick*

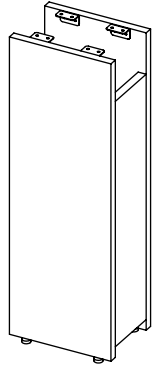
<b>Cable Tower</b>					
	<b>Plywood</b>				
	7"	10"	28"	<b>MTACT28</b>	600
	7"	10"	34.5"	<b>MTACT34</b>	720
	7"	10"	40.5"	<b>MTACT40</b>	840
	<b>TFL</b>				
	7"	10"	28"	<b>MTACT28</b>	395
	7"	10"	34.5"	<b>MTACT34</b>	455
	7"	10"	40.5"	<b>MTACT40</b>	505

*All tables come with 5 under surface cable clips and 3 cable straps for table legs*

*The heights of the Cable Tower correspond to 29.5" / 36" / 42" table heights*

*The Cable Tower can be mounted anywhere under the table surface*



# MOMENT Table Cable Management

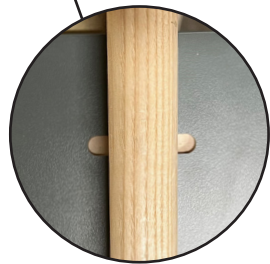
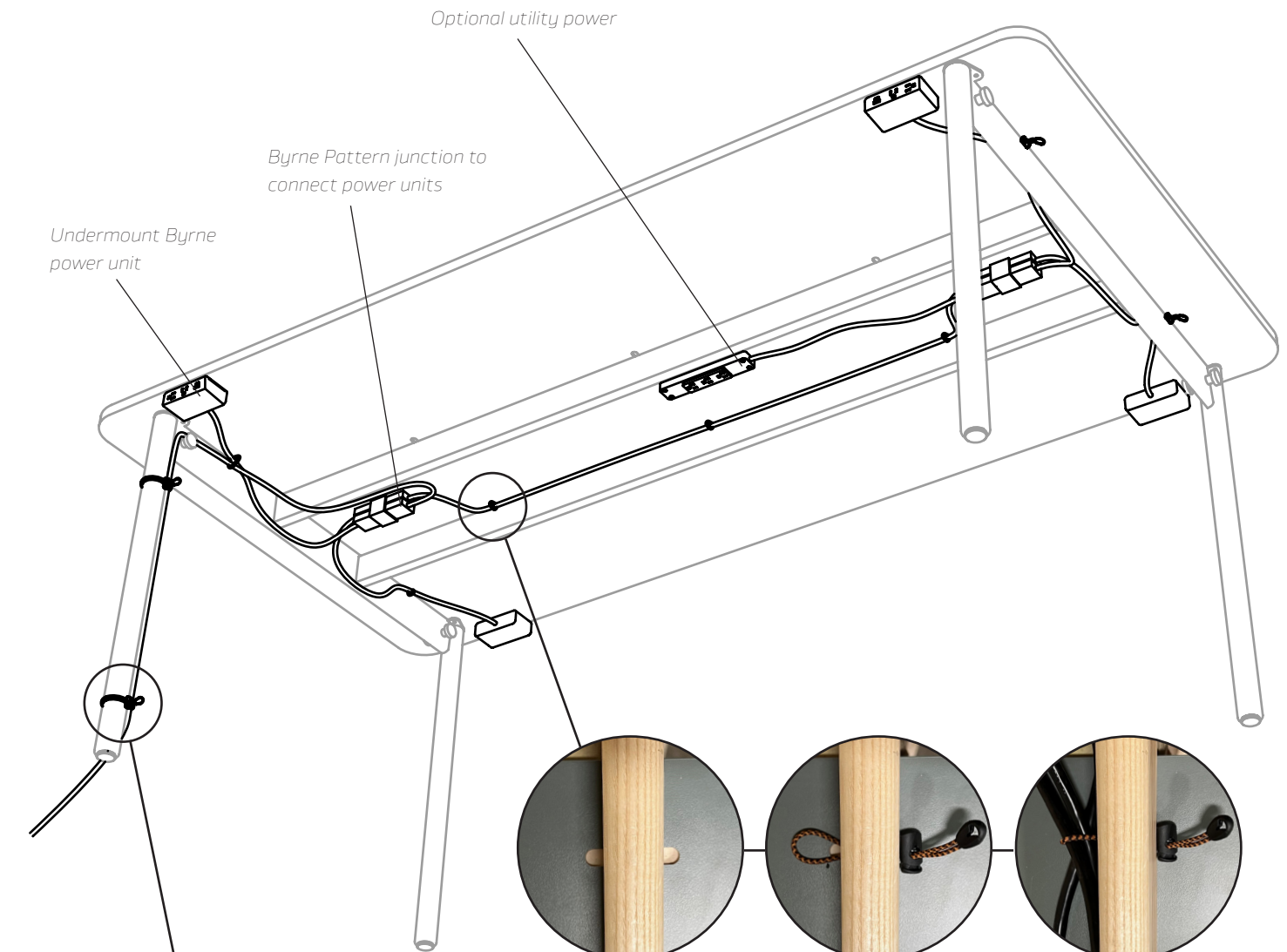

There are slots routed between the surface and the wood frame.



Bungee cords can be fed through these slots.



These bungee cords can be used to manage cables under the surface.



Adjustable bungee cords offer user configurable cable management down any table leg

### Standard on all tables:

Under Surface Cable Bungee

6x



Leg Cable Bungee

2x

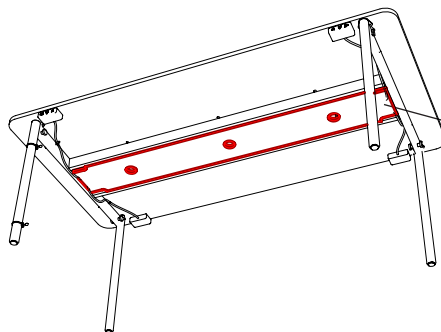

Optional plywood cable cover with magnetic attachment

# MOMENT Table Power Placement

## Social Tables

## Meeting/Perch Tables

## Community Tables

### Under Surface Perimeter Power

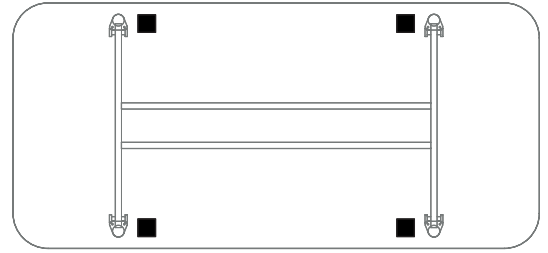
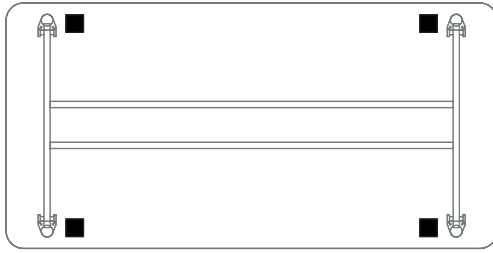
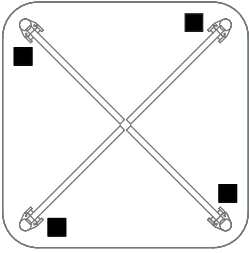

All power units are 2" back from the edge of the surface and 2" in from the interior of the table legs

### Single In-Surface Power

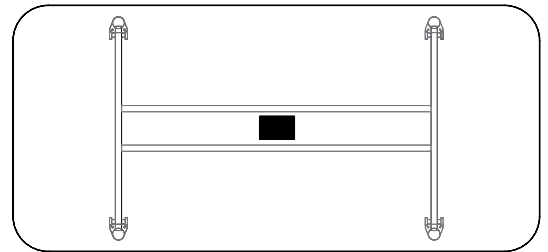
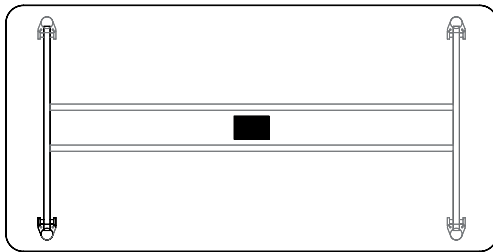
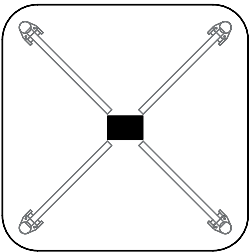

### Double In-Surface Power

NA

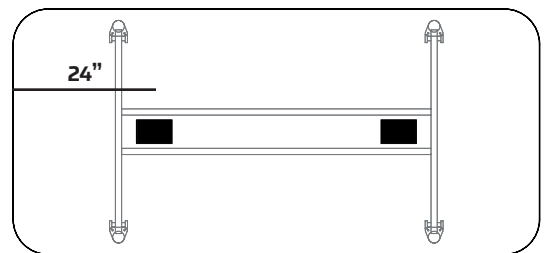
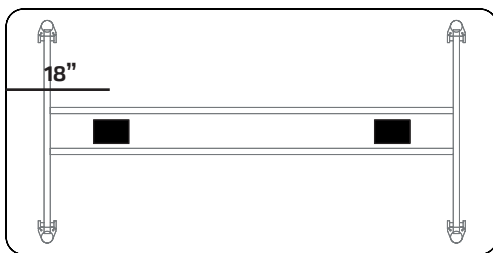

### Grommet Locations

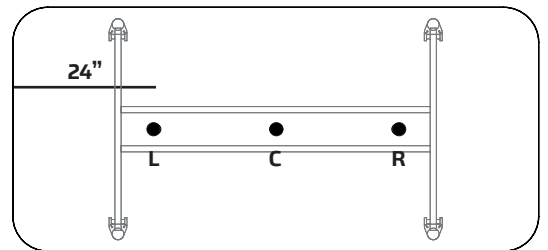
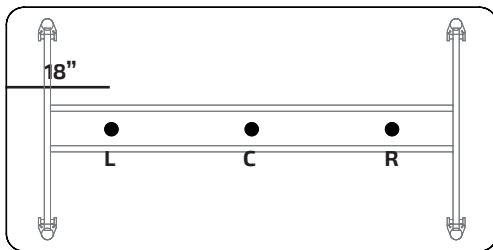
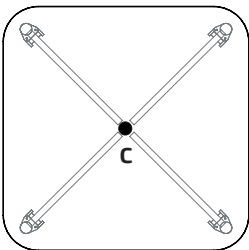

If a grommet is specified in the same location as a power unit it will be pushed 2" interior of the power unit or 2" to the right depending on the configuration. **+\$55 list per grommet**









## MOMENT Table Power Offering

### Notes:

All multi-unit configurations (perimeter power / inline utility power / or double in-surface power) are accomplished using Byrne Electric's Pattern system or our Built in USB C charging system. This mean all individual power units or ports are chained together and a single cord (infeed) powers the whole system.

### Options:

**Braided Infeed Cord:** +\$120  
**Hardwired Infeed:** +\$240  
 Finish option on Byrne website.  
 Select finishes may add extra cost.

Power Unit	Description	Perimeter*	Single In-Surface	Double In-Surface**
<b>Built in 100 Watt USB C</b>	4 port: 1 port per leg	2340	NA	NA
	<i>This power solution is proprietary to Makr Furniture and the Moment Tables &amp; Desks. It integrates a 100-Watt USB C charging port into each table leg. This is enough power to charge devices ranging from cell phones to full sized laptops. In addition to power, hardware data, peripherals, and displays can pass through these ports with the use of data Hubs. Makr can work with your technology needs to help specify the proper Hub for your application. A data hub is not included in this price.</i>			
<b>Finch</b>	 3 port: 2 PWR / USB A + C	2660	NA	NA
<b>Dean</b>	 3 port: 3 PWR 3 port: 2 PWR / 1 USB A + C	2555 3300	450 600	1210 1530
<b>Ellora B</b>	 4 port: 2 PWR / Dual USB A / 1 Open 4 port: 3 PWR / USB A + C	NA NA	750 750	2330 2330
<b>Pepper</b>	 1 port: 1 PWR	NA	150	870
<b>HQ2</b>	 4 port: 1 PWR / Dual USB A / 2 Qi	NA	995	2930
<b>Utility Power***</b>	 <i>inline</i>  <i>stand alone</i> 3 port: 3 PWR	300	300	NA

\*Perimeter power comes with 4 power units chained together into one system with a single power infeed

\*\*Double in-surface power comes with 2 power units chained together into one system with a single power infeed

\*\*\*Utility power is mounted under the surface and will be connected in line with the other power units by default. If you want a stand alone utility power unit with its own power cord it will be a 2 port byrne MiniTap and will cost \$140 list.