

|MOMENT| line



mokr
FURNITURE

THE MATERIALS





In addition to its natural appeal, ash wood is resilient, sustainable, and beautiful. Known for its light weight, strength, shock resistance and flexibility ash grants the Moment Tables incredible durability, a soft feel, and excellent mobility.



PERCH TABLES





The Perch is an exceptional tool for dividing larger space or utilizing office nooks and crannies. At standing height and equipped with a foot bar, these tables are opportunity creators, encouraging individuals or small teams to take a beat, touch down, and check in.



COMMUNITY TABLES





With a resimercial aesthetic, the Community Table is expansive yet intimate, allowing for a more casual meeting or multiple small working groups to share a single space. As a centrepiece, Community Tables are an invitation to co-locate and co-create.



MEDIA TABLES





We designed the Media Tables to solve a common problem, creating natural sight lines for digital interaction. The asymmetric taper allows for an equitable experience around the table without awkward leaning in or out.



SESSION TABLES





Comfortable and customizable, the Session Table meets your team where you are at with a wide range of size and height configurations. For the in-person or the digital meeting, the Session Tables will support your team through the brainstorm, the work party, and the deadline.



COMMON TABLES





Common tables can be layered into teaming spaces to encourage collaboration or grouped to form seating clusters in educational environments. Whether for heads down work or socializing, The Common Tables provide a versatile opportunities for groups up to four.



MOMENT BOARDS





Agility of the board was a fundamental design direction. We Achieved this via lightweight materials and intentional touch points. The full-length reveal between the frame and board lends to the impression of lightness, allowing for easy maneuverability with a comfort and minimal effort.

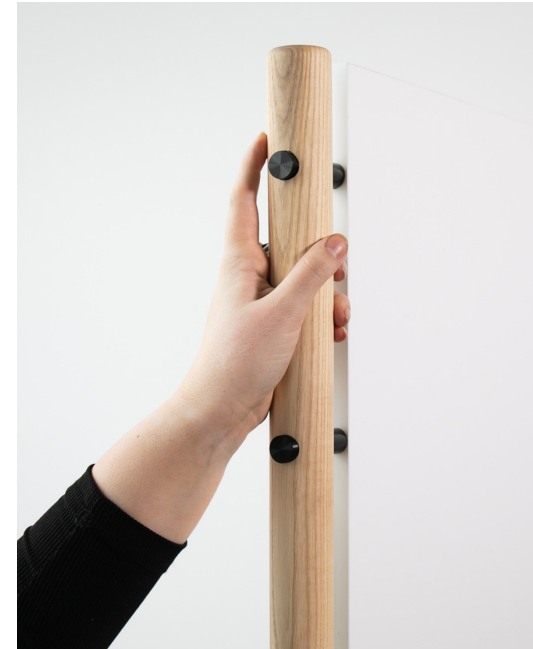

MOMENT DESKS





Moment desking reduces costs and increases flexibility by eliminating the need for a bulky and static panel and power systems. It integrates the revolutionary Byrne Pattern System that allows desks to organically form work pods of up to 12 desks powered of a single three prong plug.



DESKS MOUNTED SCREENS





Material Choices:

- Laminate (TFL/HPL)
- Whiteboard (Mirlux/Magnetic HPL)
- Tack-able upholstered screens
- Acrylic

Chamfered edge detail on the outside of fabric wrapped and PET screens

Clamp on bracket design (can work with any surface up to 1.25" thick)



MODESTY SCREENS

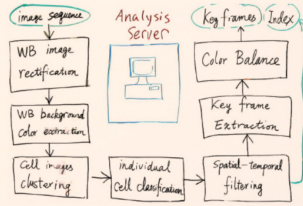



Material Choices:

Laminate (TFL/HPL)
Tack-able upholstered screens
(COM fabrics available in addition
to our standards)

Chamfered edge detail on the
outside of fabric wrapped.

Screw on design.



MOMENT Rectangular Perch Tables

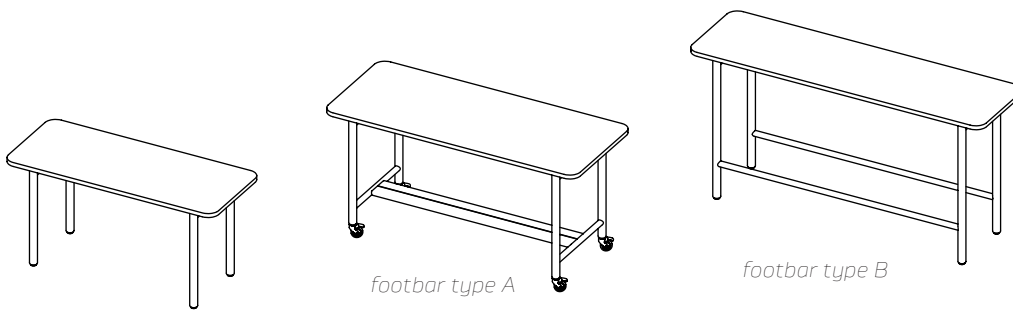

Options / Notes:

Casters: +\$90 (hieght not altered)

Custom Power Cutouts: +\$150

Table Hieght: 29.5" / 36" / 42"+\$200

***Footbar Type B:** 42" tall table ONLY

TFL Edge: edgeband ONLY

HPL Edge: edgeband / MDF 90 /
MDF Knife / MDF trim

PLY Edge: PLY 90 / PLY knife

Bag hooks standard on all tables

Dimensions			Surface Material			Footbars		Cable Cover
D	W	MODEL NUMBER	TFL	HPL/ Mirlux	PLY	TYPE A	TYPE B*	PLY
24"	48"	MTPCR2448	1570	1895	2070	+415	+240	+140
24"	60"	MTPCR2460	1665	2045	2365	+510	+400	+155
24"	72"	MTPCR2472	1765	2300	2560	+600	+430	+170
24"	84"	MTPCR2484	1860	2450	2755	+685	+460	+185
24"	96"	MTPCR2496	1910	2555	2900	+775	NA	+200
30"	48"	MTPCR3048	1640	2010	2330	+415	+240	+140
30"	60"	MTPCR3060	1740	2280	2550	+510	+400	+155
30"	72"	MTPCR3072	1850	2450	2770	+600	+430	+170
30"	84"	MTPCR3084	1960	2620	3000	+685	+460	+185
30"	96"	MTPCR3096	2010	2750	3170	+775	NA	+200

MOMENT Racetrack Perch Tables

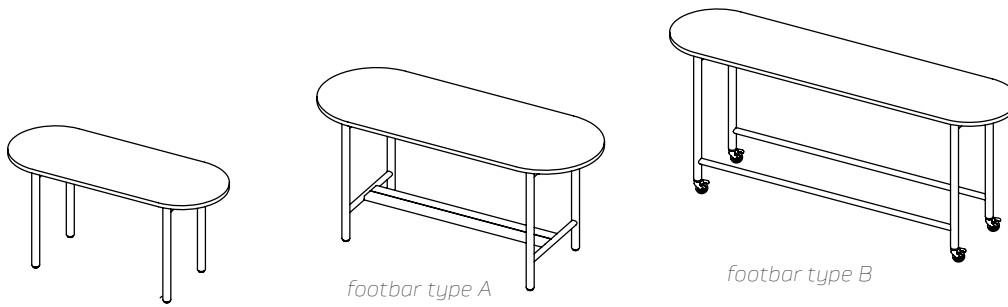

Options / Notes:

Casters: +\$90 (hieght not altered)

Custom Power Cutouts: +\$150

Table Hieght: 29.5" / 36" / 42"+\$200

***Footbar Type B:** 42" tall table ONLY

TFL Edge: edgeband ONLY

HPL Edge: edgeband / MDF 90 /

MDF Knife / MDF trim

PLY Edge: PLY 90 / PLY knife

Bag hooks standard on all tables

Dimensions			Surface Material			Footbars		Cable Cover
D	W	MODEL NUMBER	TFL	HPL/ Mirlux	PLY	TYPE A	TYPE B*	PLY
24"	60"	MTPC02460	1665	2045	2365	+510	+400	+140
24"	72"	MTPC02472	1765	2300	2560	+600	+430	+155
24"	84"	MTPC02484	1860	2450	2755	+685	+460	+170
24"	96"	MTPC02496	1910	2555	2900	+775	NA	+185
30"	60"	MTPC03060	1740	2280	2550	+510	+400	+140
30"	72"	MTPC03072	1850	2450	2770	+600	+430	+155
30"	84"	MTPC03084	1960	2620	3000	+685	+460	+170
30"	96"	MTPC03096	2010	2850	3170	+775	NA	+185

MOMENT Media Tables

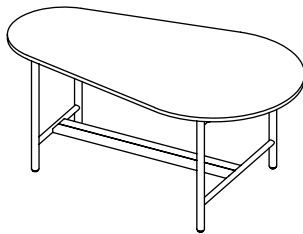
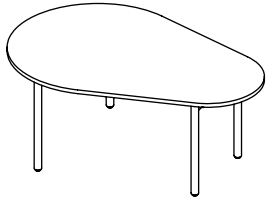

footbar type A

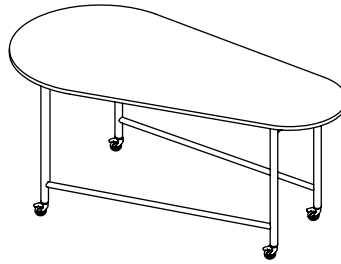

footbar type B

Options / Notes:

Casters: +\$90 (hieght not altered)

Custom Power Cutouts: +\$150

Table Hieght: 29.5" / 36" / 42"+\$200

***Footbar Type B:** 42" tall table ONLY

TFL Edge: edgeband ONLY

HPL Edge: edgeband / MDF 90 /

MDF Knife / MDF trim

PLY Edge: PLY 90 / PLY knife

Bag hooks standard on all tables

Dimensions

Surface Material

Footbars

Cable Cover

D	W	MODEL NUMBER	TFL	Surface Material		Footbars		Cable Cover
				HPL/ Mirlux	PLY	TYPE A	TYPE B*	PLY
48"	72"	MTMD4872	2490	3300	3790	+650	+400	+170
48"	84"	MTMD4884	2680	3580	4050	+740	+430	+185
48"	96"	MTMD4896	2760	3760	4400	+830	+460	+200

MOMENT Community Tables

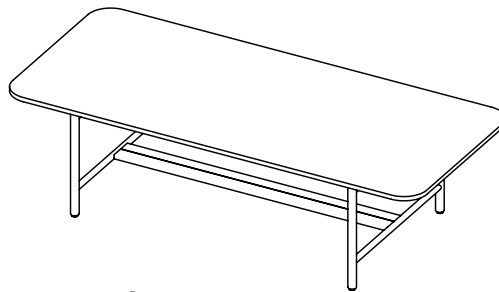
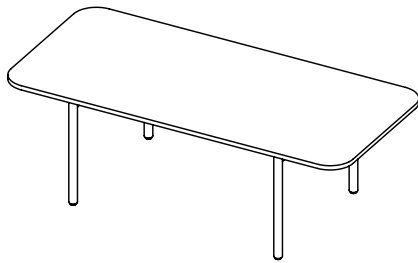

footbar type A

Options / Notes:

Casters: +\$90 (hieght not altered)

Custom Power Cutouts: +\$150

Table Hieght: 29.5" ONLY

Tops over 96" W will be two peice

TFL Edge: edgeband ONLY

HPL Edge: edgeband / MDF 90 / MDF

Knife / MDF trim

PLY Edge: PLY 90 / PLY knife

Bag hooks standard on all tables

Dimensions			Surface Material			Footbars		Cable Cover
D	W	MODEL NUMBER	TFL	HPL/ Mirlux	PLY	TYPE A	TYPE B	PLY
36"	84"	MTC3684	2050	2800	3330	+415	NA	+155
36"	96"	MTC3696	2220	2940	3530	+510	NA	+170
36"	108"	MTC36108	2441	3340	3900	+600	NA	+185
36"	120"	MTC36120	2510	3480	4100	+685	NA	+200
42"	84"	MTC4284	2580	3410	3910	+415	NA	+155
42"	96"	MTC4296	2660	3570	4140	+510	NA	+170
42"	108"	MTC42108	2900	3890	4530	+600	NA	+185
42"	120"	MTC42120	2980	4050	4760	+685	NA	+200
48"	84"	MTC4884	2680	3580	4150	+455	NA	+245
48"	96"	MTC4896	2760	3760	4400	+560	NA	+275
48"	108"	MTC48108	3010	4100	4830	+650	NA	+305
48"	120"	MTC48120	3090	4280	5080	+740	NA	+335
<i>*Surface material options may be limited above 48" table depth</i>								
54"	84"	MTC5484	2770	3750	4390	+455	NA	+290
54"	96"	MTC5496	2860	3950	4670	+560	NA	+340
54"	108"	MTC54108	3120	4310	5120	+650	NA	+380
54"	120"	MTC54120	3210	4510	5400	+740	NA	+430
60"	84"	MTC6084	2860	3920	4620	+595	NA	+340
60"	96"	MTC6096	2970	4140	4940	+700	NA	+400
60"	108"	MTC60108	3230	4520	5410	+790	NA	+460
60"	120"	MTC60120	3330	4740	5730	+880	NA	+520

MOMENT Rectangular Session Tables

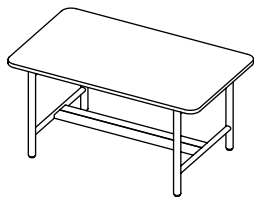

footbar type A

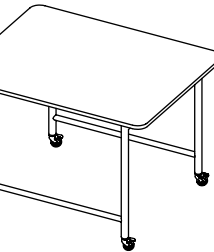
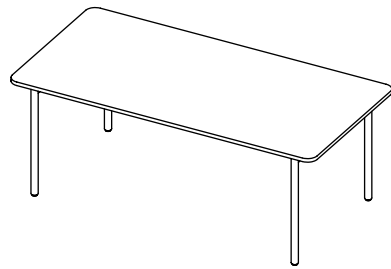

footbar type B

Options / Notes:

Casters: +\$90 (hieght not altered)

Custom Power Cutouts: +\$150

Table Hieght: 29.5" / 36" / 42"+\$200

***Footbar Type B:** 42" tall table ONLY

TFL Edge: edgeband ONLY

HPL Edge: edgeband / MDF 90 /

MDF Knife / MDF trim

PLY Edge: PLY 90 / PLY knife

Bag hooks standard on all tables

Dimensions			Surface Material			Footbars		Cable Cover
D	W	MODEL NUMBER	TFL	HPL/ Mirlux	PLY	TYPE A	TYPE B*	PLY
36"	48"	MTMR3648	1700	2220	2480	+415	+240	+140
36"	60"	MTMR3660	1820	2420	2730	+510	+400	+155
36"	72"	MTMR3672	1930	2600	2980	+600	+430	+170
36"	84"	MTMR3684	2050	2800	3330	+685	+460	+185
36"	96"	MTMR3696	2220	2940	3530	+775	NA	+200
42"	60"	MTMR4260	2240	2790	3150	+510	+400	+155
42"	72"	MTMR4272	2410	23050	3580	+600	+430	+170
42"	84"	MTMR4284	2580	3410	3910	+685	+460	+185
42"	96"	MTMR4296	2660	3670	4140	+775	NA	+200
48"	60"	MTMR4860	2310	2920	3430	+560	+400	+245
48"	72"	MTMR4872	2590	3200	3790	+650	+430	+275
48"	84"	MTMR4884	2680	3580	4150	+740	+460	+305
48"	96"	MTMR4896	2760	3760	4400	+830	NA	+335
<i>*Surface material options may be limited above 48" table depth</i>								
54"	72"	MTMR5472	2580	3450	4000	+650	+430	+340
54"	84"	MTMR5484	2770	3750	4390	+740	+460	+380
54"	96"	MTMR5496	2860	3950	4670	+830	NA	+430
60"	72"	MTMR6072	2660	3600	4210	+790	+430	+400
60"	84"	MTMR6084	2860	3920	4620	+880	+460	+460
60"	96"	MTMR6096	2970	4140	4940	+970	NA	+520

MOMENT Racetrack Session Tables

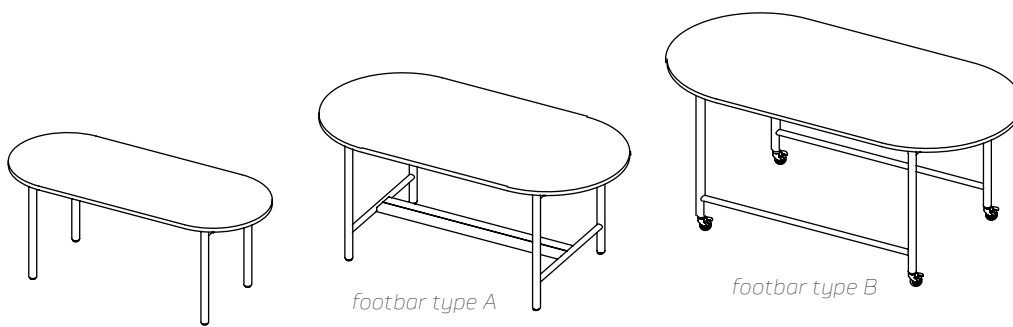

Options / Notes:

Casters: +\$90 (hieght not altered)

Custom Power Cutouts: +\$150

Table Hieght: 29.5" / 36" / 42"+\$200

***Footbar Type B:** 42" tall table ONLY

TFL Edge: edgeband ONLY

HPL Edge: edgeband / MDF 90 /

MDF Knife / MDF trim

PLY Edge: PLY 90 / PLY knife

Bag hooks standard on all tables

Dimensions			Surface Material			Footbars		Cable Cover
D	W	MODEL NUMBER	TFL	HPL/ Mirlux	PLY	TYPE A	TYPE B*	PLY
36"	60"	MTM03660	1820	2420	2730	+510	+400	+140
36"	72"	MTM03672	1930	2600	2980	+600	+430	+155
36"	84"	MTM03684	2050	2800	3330	+685	+460	+170
36"	96"	MTM03696	2220	2940	3530	+775	NA	+185
42"	72"	MTM04272	2410	3050	3580	+600	+430	+155
42"	84"	MTM04284	2580	3310	3910	+685	+460	+170
42"	96"	MTM04296	2660	3570	4140	+775	NA	+185
48"	72"	MTM04872	2490	3300	3790	+650	+430	+245
48"	84"	MTM04884	2680	3580	4150	+740	+460	+275
48"	96"	MTM04896	2760	3760	4400	+830	NA	+305
<i>*Surface material options may be limited above 48" table depth</i>								
54"	84"	MTM05484	2770	3750	4390	+740	+460	+340
54"	96"	MTM05496	2860	3950	4770	+830	NA	+380
60"	96"	MTM06096	2970	4140	4940	+970	NA	+460

MOMENT Common Tables

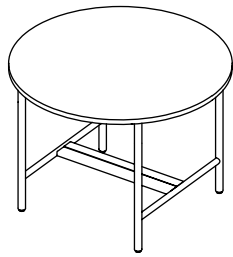
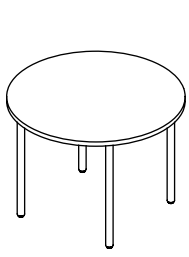

footbar type A

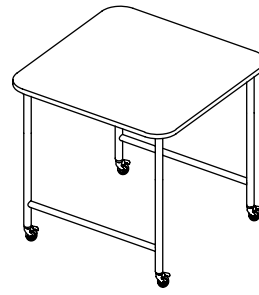
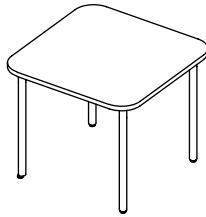

footbar type B

Options / Notes:

Casters: +\$90 (hieght not altered)

Custom Power Cutouts: +\$150

Table Hieght: 29.5" / 36" / 42"+\$200

***Footbar Type B:** 42" tall table ONLY

TFL Edge: edgeband ONLY

HPL Edge: edgeband / MDF 90 /

MDF Knife / MDF trim

PLY Edge: PLY 90 / PLY knife

Bag hooks standard on all tables

Round

Round			Surface Material			Footbars		Cable Cover
D	W	MODEL NUMBER	TFL	HPL/ Mirlux	PLY	TYPE A	TYPE B*	PLY
42"	42"	MTSR4242	1940	2505	2800	+415	+240	NA
48"	48"	MTSR4848	2005	2620	2955	+470	+250	NA
54"	54"	MTSR5454	2270	2885	3400	+510	+400	NA
60"	60"	MTSR6060	2440	3165	3775	+700	+410	NA

Square

D	W	MODEL NUMBER	TFL	HPL/ Mirlux	PLY	TYPE A	TYPE B*	Ply
42"	42"	MTSS4242	1940	2505	2800	+415	+240	NA
48"	48"	MTSS4848	2005	2620	2955	+470	+250	NA
54"	54"	MTSS5454	2270	2885	3400	+510	+400	NA
60"	60"	MTSS6060	22440	3165	3775	+700	+410	NA

MOMENT Table Accessories

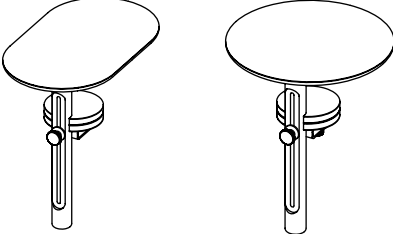
	D	W	H	MODEL NUMBER	Price
Pivot Tables					
	Racetrack				
	12"	20"	20"	MTAPTO	600
	Round				
	16"	16"	20"	MTAPTR	600

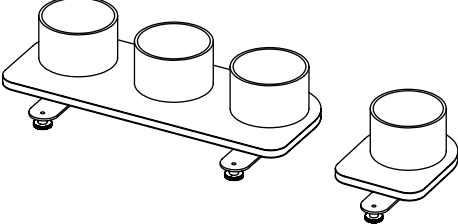
Planters					
	Single				
	12"	9"	9"	MTAPL1	250
	Tripple				
	12"	24"	9"	MTAPL3	400

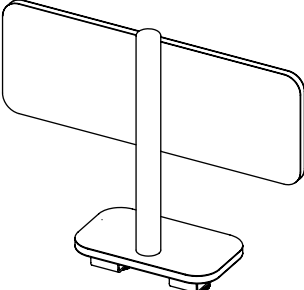
TV Mount	8"	28"	24"	MTATV	700
					

Pivot Table / Planters / TV Mount can clamp onto any surface less than 1.25" thick

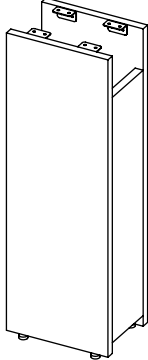
Cable Tower					
	Plywood				
	7"	10"	28"	MTACT28	500
	7"	10"	34.5"	MTACT34	600
	7"	10"	40.5"	MTACT40	700
	TFL				
	7"	10"	28"	MTACT28	330
7"	10"	34.5"	MTACT34	380	
7"	10"	40.5"	MTACT40	420	

All tables come with 5 under surface cable clips and 3 cable straps for table legs

The heights of the Cable Tower correspond to 29.5" / 36" / 42" table heights

The Cable Tower can be mounted anywhere under the table surface

MOMENT Table Cable Management

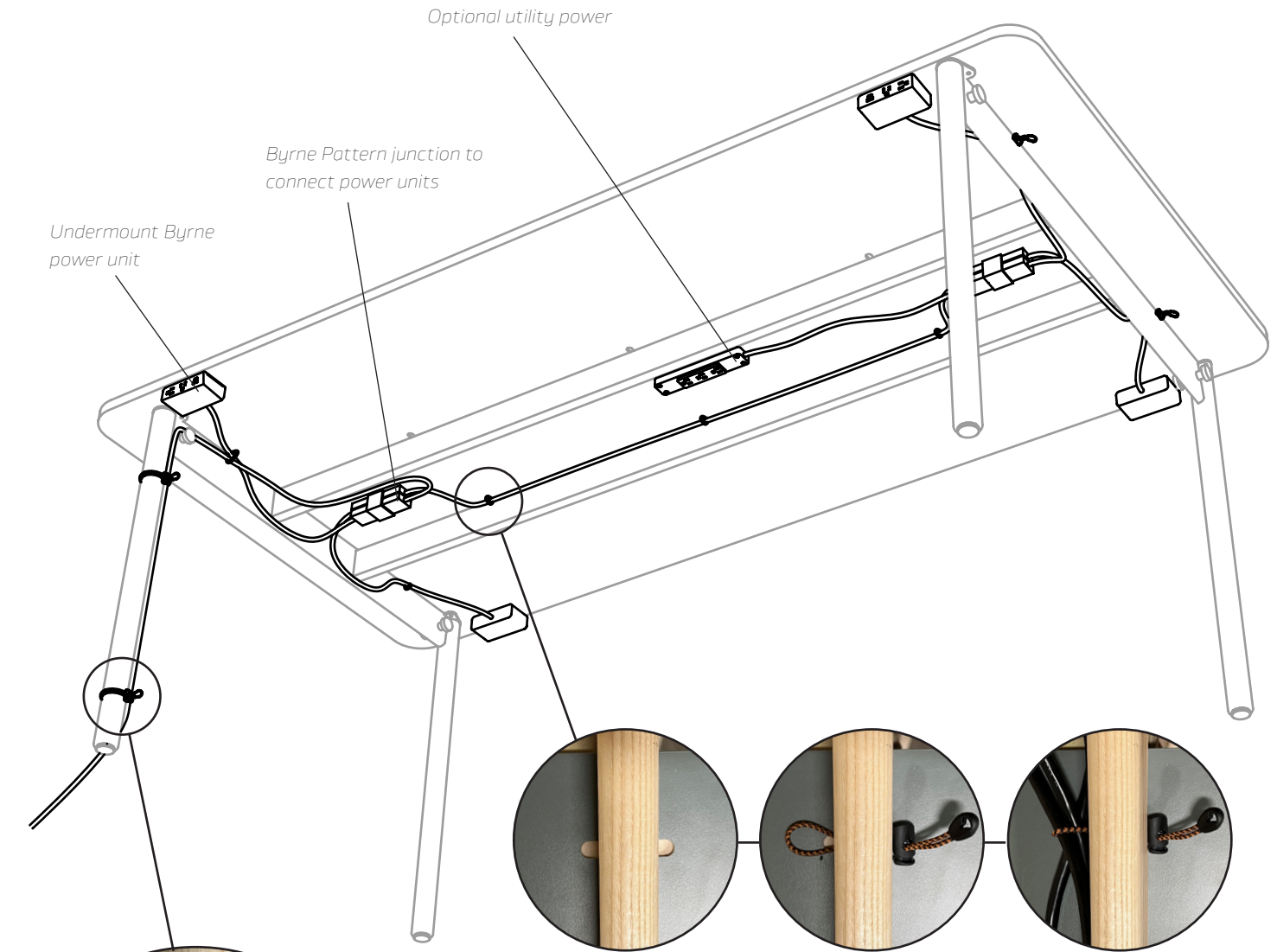

There are slots routed between the surface and the wood frame.

Bungee cords can be fed through these slots.

These bungee cords can be used to manage cables under the surface.

Standard on all tables:

Under Surface Cable Bungee

6x



Leg Cable Bungee

2x



Adjustable bungee cords offer user configurable cable management down any table leg

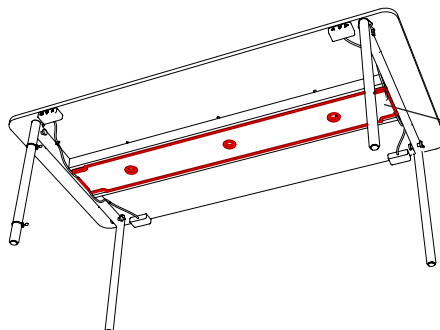

Optional plywood cable cover with magnetic attachment

MOMENT Table Power Placement

Social Tables

Meeting/Perch Tables

Community Tables

Under Surface Perimeter Power

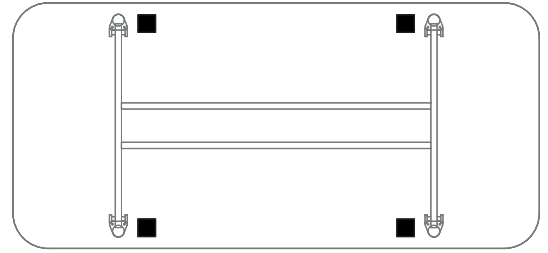
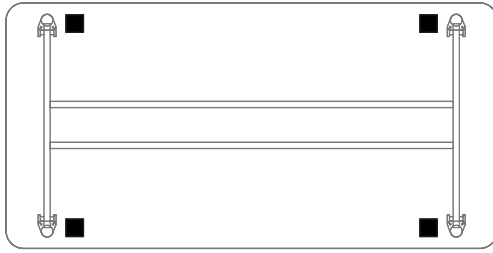
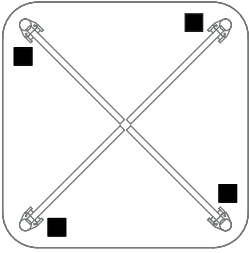

All power units are 2" back from the edge of the surface and 2" in from the interior of the table legs

Single In-Surface Power

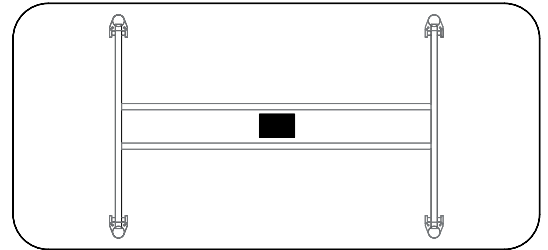
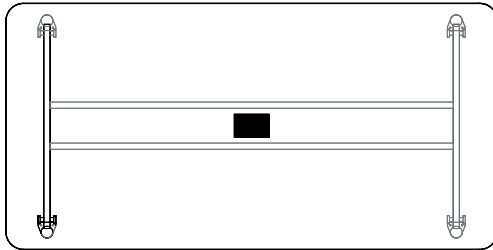
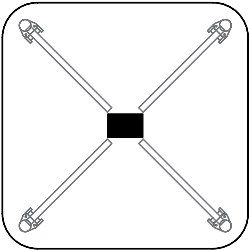

Double In-Surface Power

NA

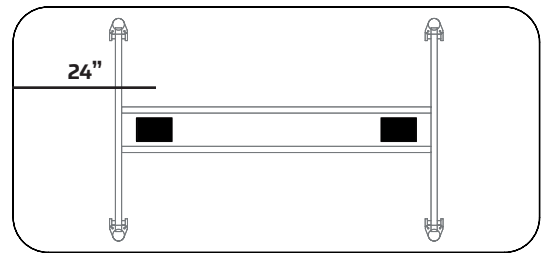
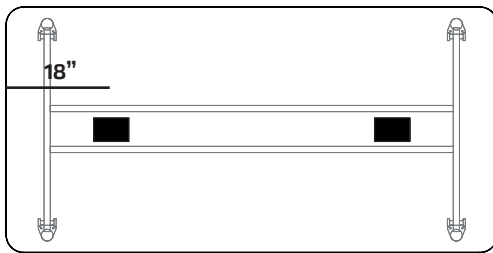

Grommet Locations

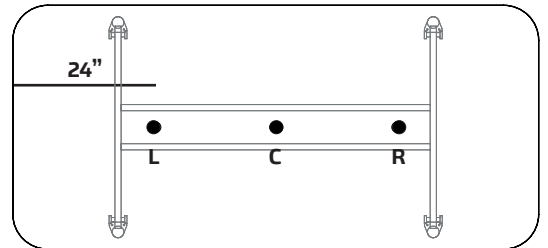
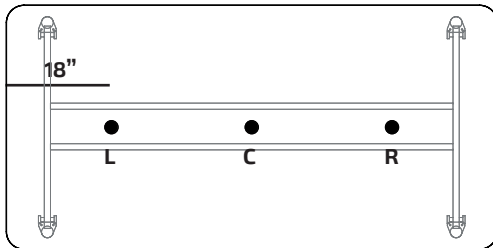
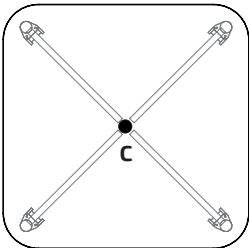

If a grommet is specified in the same location as a power unit it will be pushed 2" interior of the power unit or 2" to the right depending on the configuration. **+\$55 list per grommet**

MOMENT Table Power Offering

Notes:









All multi-unit configurations (perimeter power / inline utility power / or double in-surface power) are accomplished using Byrne Electric's Pattern system or our Built in USB C charging system. This means all individual power units or ports are chained together and a single cord (infeed) powers the whole system.

Options:

Braided Infeed Cord: +\$100

Hardwired Infeed: +\$200

Finish option on Byrne website.
Select finishes may add extra cost.

Power Unit	Description	Perimeter*	Single In-Surface	Double In-Surface**
Built in 100 Watt USB C	4 port: 1 port per leg	1950	NA	NA
	<i>This power solution is proprietary to Makr Furniture and the Moment Tables & Desks. It integrates a 100-Watt USB C charging port into each table leg. This is enough power to charge devices ranging from cell phones to full sized laptops. In addition to power, hardware data, peripherals, and displays can pass through these ports with the use of data Hubs. Makr can work with your technology needs to help specify the proper Hub for your application. A data hub is not included in this price.</i>			
Finch	 3 port: 2 PWR / USB A + C	2660	NA	NA
Dean	 3 port: 3 PWR 3 port: 2 PWR / 1 USB A + C	2130 2750	375 500	1010 1275
Ellora B	 4 port: 2 PWR / Dual USB A / 1 Open 4 port: 3 PWR / USB A + C	NA NA	625 625	1940 1940
Pepper	 1 port: 1 PWR	NA	125	725
HQ2	 4 port: 1 PWR / Dual USB A / 2 Qi	NA	830	2440
Utility Power***	 inline  stand alone 3 port: 3 PWR	250	250	NA

*Perimeter power comes with 4 power units chained together into one system with a single power infeed

**Double in-surface power comes with 2 power units chained together into one system with a single power infeed

***Utility power is mounted under the surface and will be connected in line with the other power units by default. If you want a stand alone utility power unit with its own power cord it will be a 2 port Byrne MiniTap and will cost \$115 list.



MAKR FURNITURE

ADDRESS

8805 S 190th St
Kent, WA 98031

CONTACT

www.makr-furniture.com

P: 253.872.3900

F: 253.872.733

info@makr-furniture.com



makr
FURNITURE