



|MOMENT|

DESKING SOLUTIONS

makr
FURNITURE

MOMENT DESKS

Moment Desking is the perfect solution for the needs of the modern office. Celebrating natural materiality with sleek, minimalistic design, each desk acts as a building block, which can be combined, added, removed, and constructed into layouts that meet the needs of any team.

VARIOUS DRAWER OPTIONS AVAILABLE:



PENCIL DRAWER



PENCIL DRAWER
W/OPEN STORAGE



PENCIL &
STORAGE



PENCIL & FILE
DRAWER



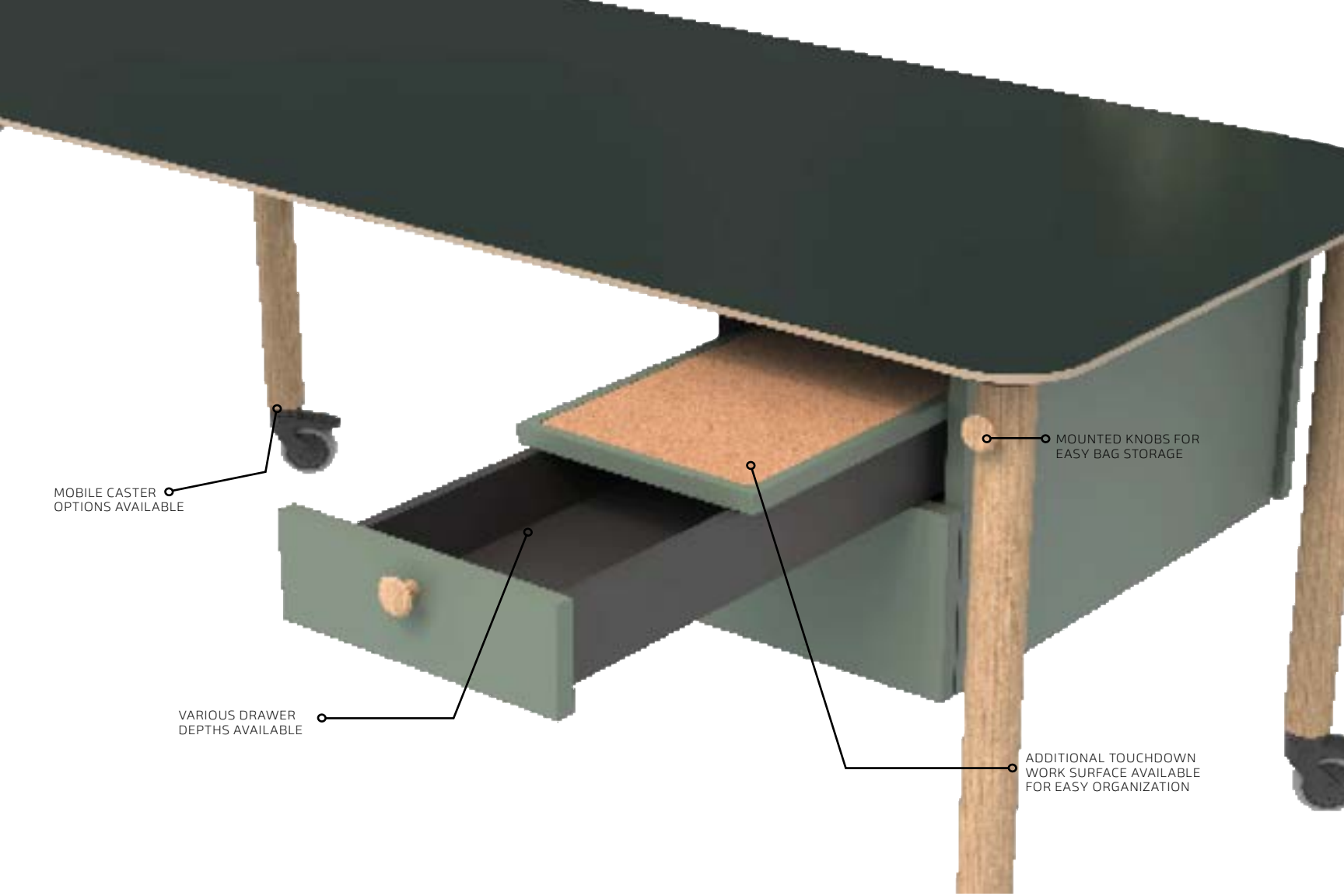

MOBILE CASTER
OPTIONS AVAILABLE

VARIOUS DRAWER
DEPTHS AVAILABLE

MOUNTED KNOBS FOR
EASY BAG STORAGE

ADDITIONAL TOUCHDOWN
WORK SURFACE AVAILABLE
FOR EASY ORGANIZATION

FORMABLE SPACES



Moment desking reduces costs and increases flexibility by eliminating the need for a bulky and static panel and power systems. It integrates the revolutionary Byrne Pattern System that allows desks to organically form work pods of up to 12 desks powered of a single three prong plug.

Desks can be disconnected, removed, relocated, and reconnected to different pods, all with a single user accessible connector, providing ultimate flexibility to reconfigure and adapt spaces.



LAYOUT EXAMPLES

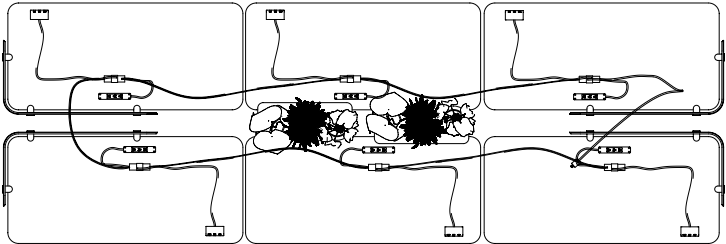
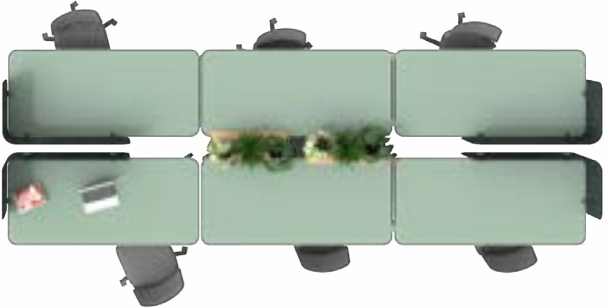
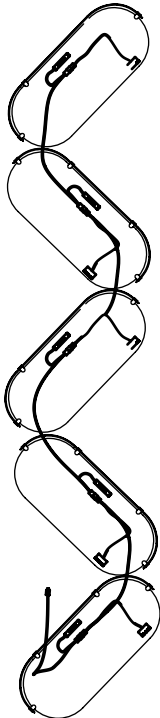

Mounted under desk wiring options allow for flexibility of configuration

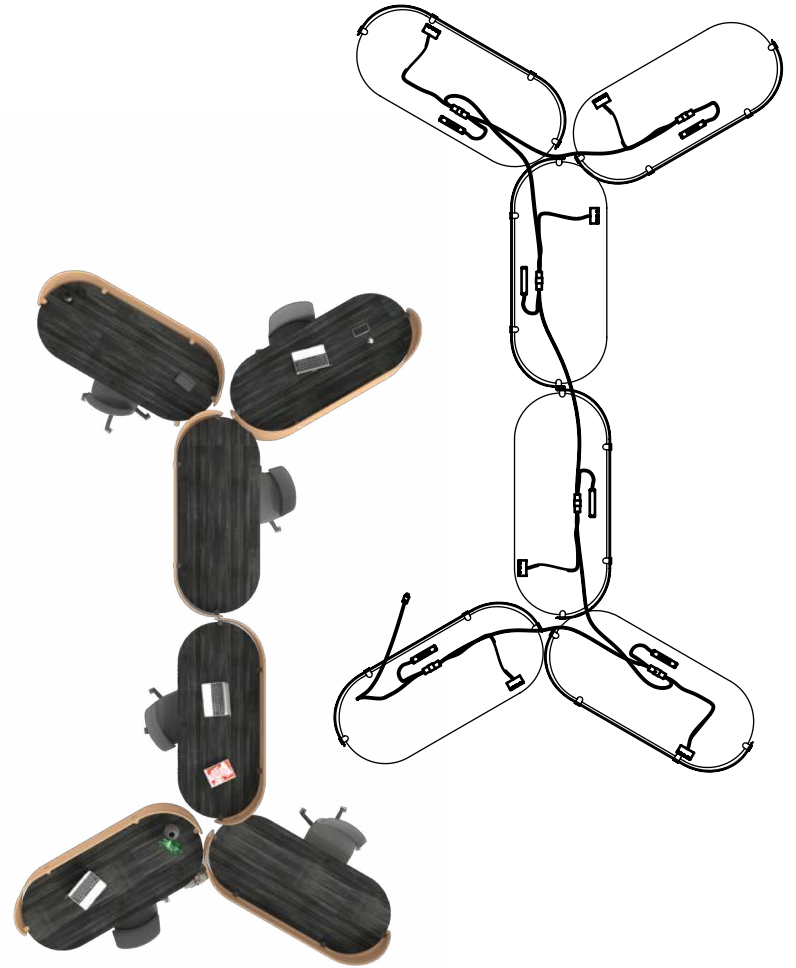
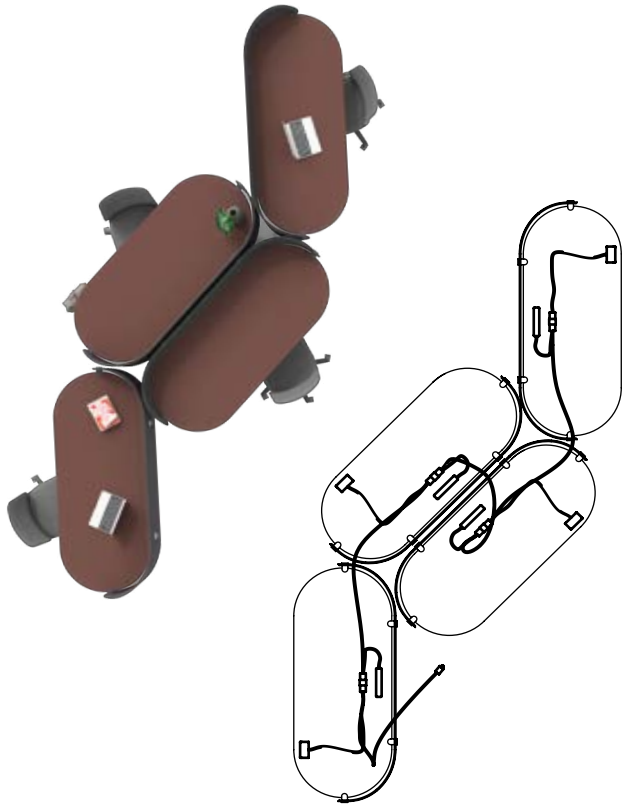

Whatever space you are working with,
there is no limit when it comes to layout
with this sleek and innovative design

POWER & DATA SOLUTIONS

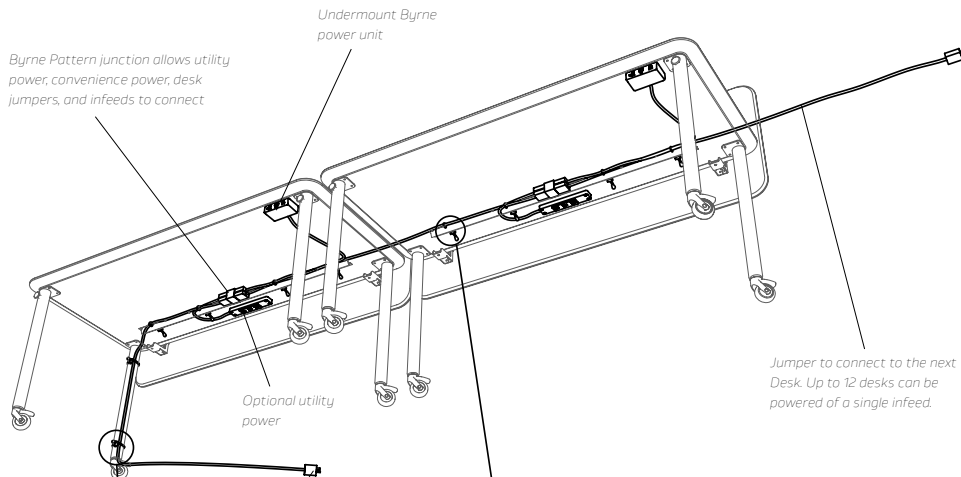

10' Power infeed. 20 amp head or hardwire whip options

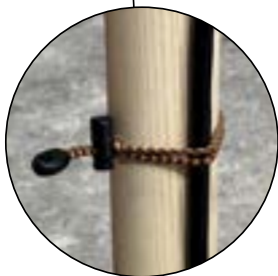

Adjustable bungee cords offer user configurable cable management down any table leg

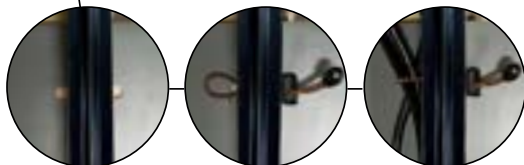

There are slots routed between the surface and the wood frame.

Bungee cords can be fed through these slots.

These bungee cords can be used to manage cables under the surface.

Standard on all tables:

Under Surface Cable Bungee

4x



Leg Cable Bungee

2x



Power Unit

Finch Undermount



Finch Edgemount



Dean Undermount



Dean Edgemount



DESK MOUNTED SCREENS

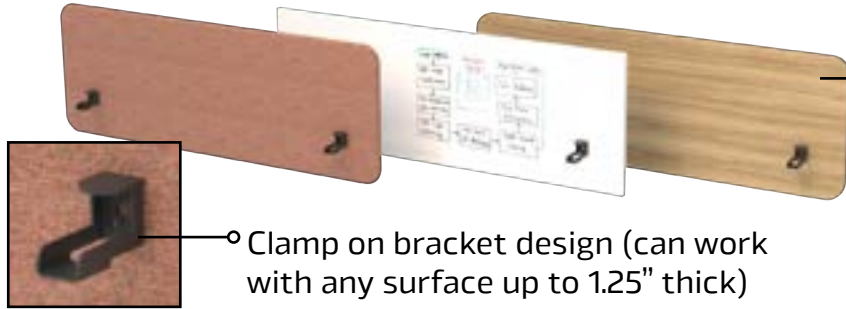

◦ Clamp on bracket design (can work with any surface up to 1.25" thick)

◦ Material Choices:

Laminate (TFL/HPL)
Whiteboard (Mirlux/Magnetic HPL)
Tack-able upholstered screens
Acrylic



◦ PET Corner Screens

Square corners option and 3" diameter radius corner option

Chamfered edge detail
on the outside of fabric
wrapped and PET screens

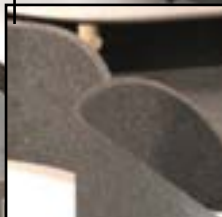

Anodized aluminum medallions
on the outside of the screens,
black or silver



MODESTY SCREENS

Material Choices:

Laminate (TFL/HPL)

Tack-able upholstered screens (COM fabrics available in addition to our standards)

Anodized aluminum medallions on the outside of the screens, black or silver



Chamfered edge detail on the outside of fabric wrapped.

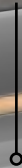

Screw on design.





MAKR FURNITURE

ADDRESS

8805 S 190th St
Kent, WA 98031

CONTACT

www.makr-furniture.com

P: 253.872.3900
F: 253.872.733

info@makr-furniture.com

makr
FURNITURE